

PASSENGER ELEVATOR MODERNIZATION

It's time to update your elevator by

ELEMOTION

Aging elevator – Deterioration becomes a concern...

As elevators age, ride quality deteriorates, running costs increase and downtime becomes longer as a result of breakdowns or maintenance work.

Is your elevator showing any of these signs?



Issue 1 Safety & quality

Deterioration over a long period of use leads to increased vibration and reduced safety.

Issue 2 Running costs

Older equipment can lead to higher repair costs and an increase in power consumption. Mounting operating costs can greatly affect building's budget.

Issue 3 Longer downtimes

Deteriorating equipment means more frequent breakdowns. Subsequent repair work could also mean disruption of service resulting in prolonged downtime.

Issue 4 Poor impression

Older elevators give poor impressions because the service is less efficient, and the appearance and design are less attractive than those of modern elevators in a new building.

Even regular maintenance cannot prevent the deterioration of elevators.

Elevators have limited lifecycles.

Just like other building equipment, elevators also require updating. They are designed for a service life of approximately 20 to 25 years.*

*As of October 2017. Reference number of years based on in-house research.



Machinery deteriorates despite continuous maintenance.

Even periodical maintenance work cannot prevent progressive deterioration of core components such as traction machines and control equipment. Furthermore, updating to meet societal requirements is also necessary, including responding to newly introduced laws and regulations.

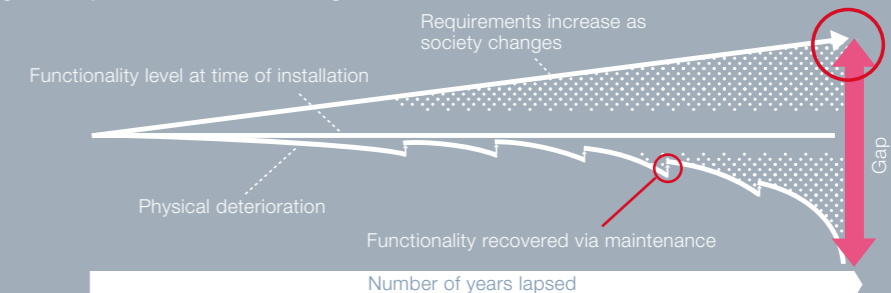

Now...

is the time for modernization!

ELEMOTION resolves these issues!

Reduce the burden on the building and update to a safer and more comfortable elevator. Instead of replacing the entire system, only replace the equipment that requires updating. That's the modernization offered by our ELEMOTION.

Effect 1 Improved sense of security

Devices and components that have degraded over time are updated. Safety and ride comfort will also be improved.

Effect 2 Improved ecology and environment

Latest devices offer greater energy efficiency and parts that last longer are retained and reused.

Effect 3 Reduced frustration

By replacing with state-of-the-art equipment, failure rate and repair time will be significantly reduced - maximizing uptime.

Effect 4 Improved image

The latest operation system and signal fixtures will create a positive image like a modern building.

Our modernization offers significant upgrades compatible with existing major components.

Reliability & Safety

Maximum effects achieved at minimum cost by replacing only those parts necessary

Instead of replacing the entire elevator, replacing only essential components / equipment helps to maintain renewal expenses at a reasonable level. In addition, by reducing the influence on building operations as much as possible, a shorter installation period can be achieved.

Major components replaced

- 1 Traction machine
- 2 Control panel
- 3 Door motor
- 4 Various signal fixtures

Please refer to page 21 for details.

State-of-the-art technologies boost reliability and safety.

Replaceable equipment include all of the latest models, which boast cutting-edge technologies and comply with all the relevant laws and regulations. Additionally, elevator reliability and safety will be enhanced as a result of replacement with latest machinery.

Comfortable & Energy Efficient

More user-friendly, comfortable and with higher energy efficiency

State-of-the-art technologies transform aging elevators into a more comfortable, user-friendly moving space. Modernization also achieves substantial energy savings compared to previous systems.

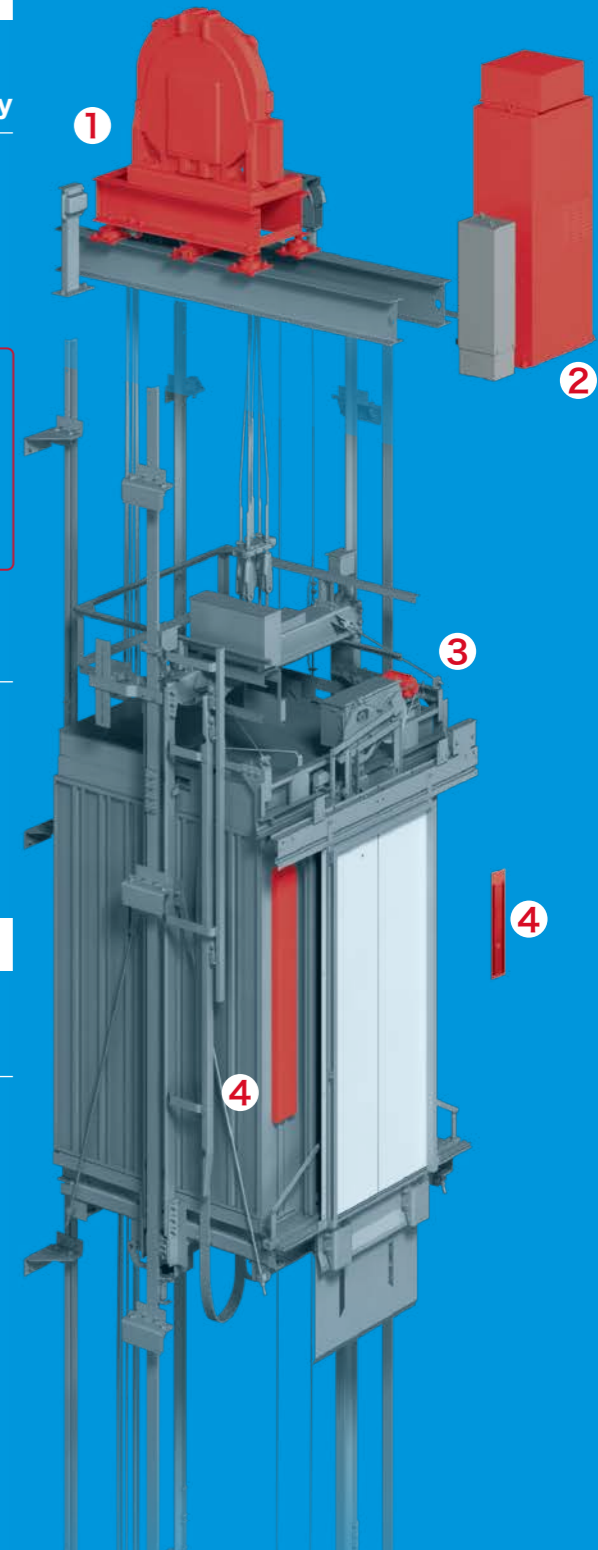

So...

we recommend ELEMOTION!

Scan the barcode to watch our video on Modernization Solutions.





Reliability & Safety

Designs optimized for interchangeability increase reliability and safety tremendously.

Higher reliability

By replacing existing equipment with current innovations, basic functionality and durability are enhanced. As a result, problems will be minimized and elevators can be used with a greater sense of security.

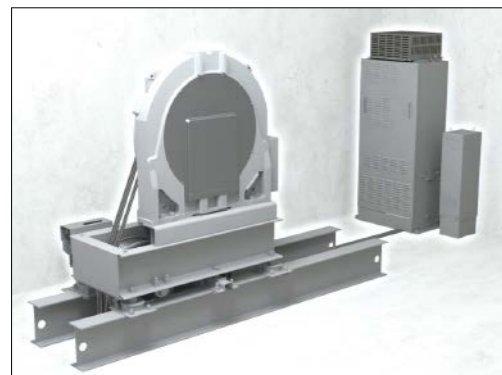
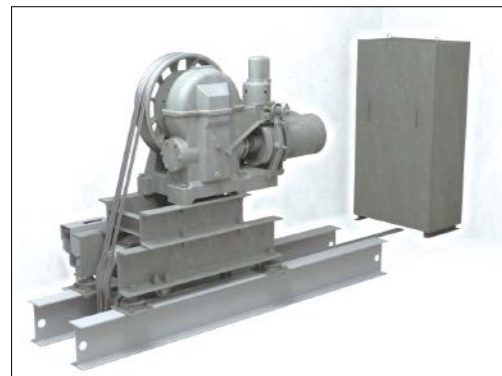

Advanced maintenance engineering

State-of-the-art maintenance with computers enables problems to be addressed quickly and reduces restoration downtime. Through replacement with the newest equipment, a continuous supply of replacement parts is ensured.



Improved precision of landing alignment

Thanks to leading-edge control technology, the ability of the car to stop precisely flush with the landing has been increased. Misalignment of the car sill with the landing sill is diminished.

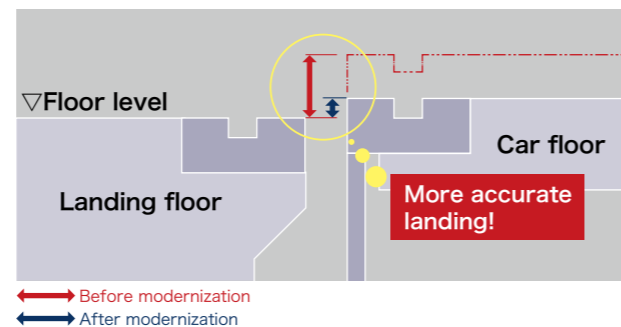

Distinctive gearless traction machine with state-of-the-art PM motor (PM: permanent magnet)

The traction machine is the most important component of an elevator. We manufacture high-precision motors by making use of our unique motor and wire winding technologies. Moreover, the traction machine comes with double brakes as standard, which boosts braking performance significantly.

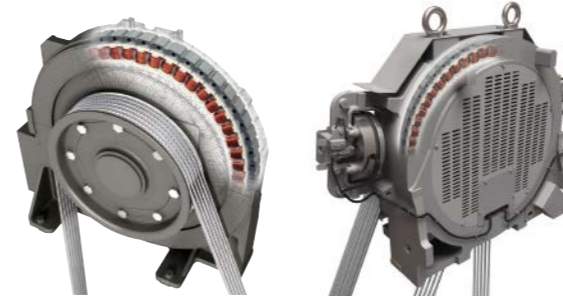

Please refer to Modernization Menu on page 21 for details.

Protection against accidental car movement

•Unintended Car Movement Protection [UCMP] <For EN standards> (Optional*1,*2)

Equipped with double brakes, the car is stopped securely in the rare case of a malfunction where the car starts to move with the doors open.

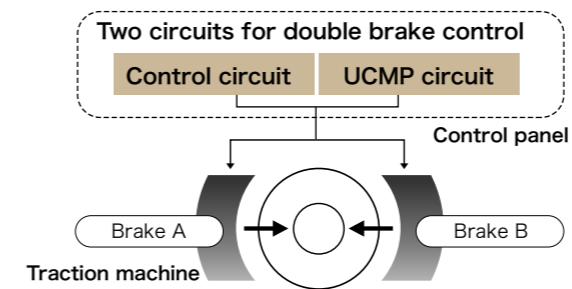

•Ascending Car Overspeed Protection [ACOP] <For EN standards> (Optional*1,*2)

If some sort of malfunction should cause a car to ascend at an abnormally high speed, the overspeeding car stops automatically to prevent it from striking the hoistway ceiling.

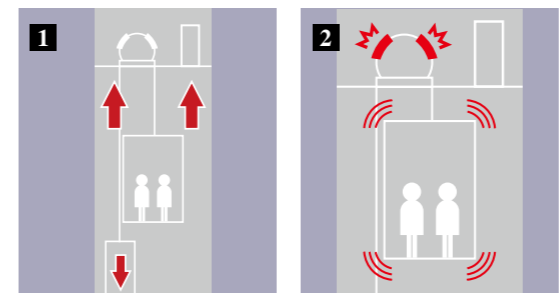

1 The car ascends at high speed. 2 Traction machine brakes safely stop the car.

Safe door operation ensured by refined features

Door-related features, renowned for their safety and reliability, have been even further improved.

•Multi-beam Door Sensor (Optional*2)

If the sensor detects a person or object between closing doors, the doors immediately reverse to open to prevent anyone or anything from being caught.

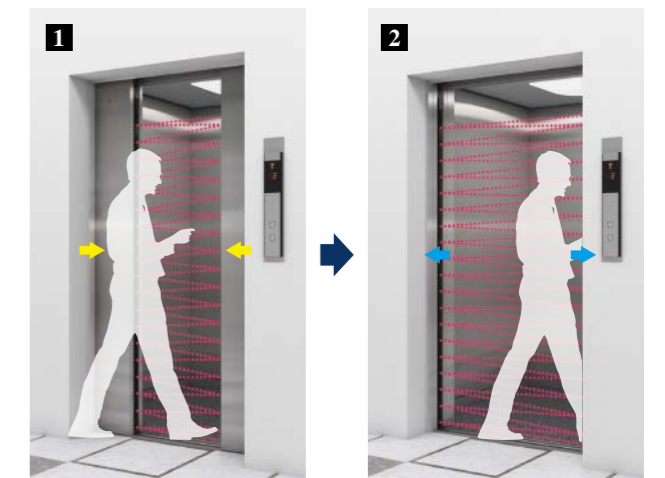

1 A person or object is detected. 2 The closing doors reverse to open.

•Door Load Detector [DLD]*3 (Standard)

If an obstacle has been caught between the doors and an abnormal door load is detected when opening or closing, the doors immediately reverse to prevent an accident or malfunction.

•Repeated Door-close [RDC]*3 (Standard)

If an obstacle has become lodged in a sill groove and prevents the doors from closing completely, the doors will repeatedly open and close until the obstacle is removed from the doorway.

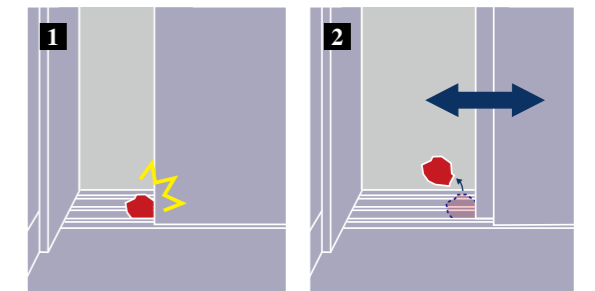

1 An obstacle is lodged in the sill groove. 2 The closing doors reverse to open and repeat closing and opening until the obstacle is removed.

Notes:

*1: Replacement of the entire traction machine is required for compatibility with this safety system.

*2: This safety system is an optional feature, but may be required in accordance with relevant laws, regulations or other requirements.

*3: The feature may be installed in the elevator which is currently in use. Please refer to pages 17 to 20 for other features.

Comfort & Energy Conservation

Offers great comfort for passengers while also achieving higher levels of energy conservation.

Smooth control using high-speed CPU



The introduction of high-density, integrated LSI digital control circuitry resulted in a significant increase in computer processing speed, enabling precise control of the traction motor for acceleration and deceleration. This innovation delivers a quality ride with minimal noise and vibration.

Improving riding comfort and energy efficiency through modernization from an old system with relay circuits

Modernizing an elevator, especially if it was manufactured around 1990 or before and is not equipped with a VVVF motor drive, can drastically boost its fundamental performance.

Control Panel with VVVF Inverter Control (Low speed elevator)*4

A control panel with VVVF inverter control, using advanced power electronics, exerts remarkable effects: reduction in energy consumption and traveling time and increased riding comfort during acceleration and deceleration.

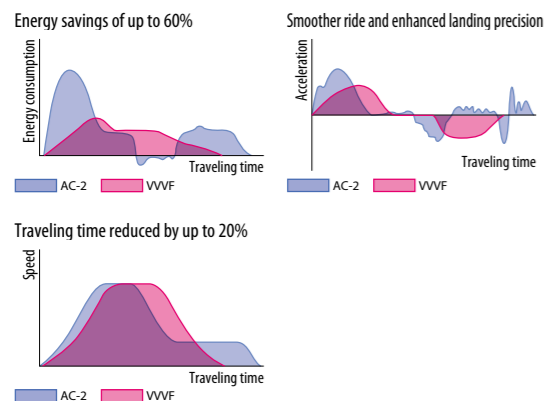

Door Motor with VVVF Inverter Control

Replacing an old door motor with a new one employing VVVF inverter control realizes smoother door operation.



Change of basic system configuration

Our long-term commitment to developing energy-efficient elevators has created systems and functions that make intelligent use of power.

	1970	1980	1990	2000	2010	2020
Motor	for High speed for Low speed	DC motor		Induction motor	Permanent magnet motor	
Traction machine	for High speed for Low speed	Gearless		Helical Geared	Gearless	
Motor drive	for High speed for Low speed	Worm Geared			Gearless	
Control circuit	for High speed for Low speed	Ward Leonard system	Thyristor control		VVVF*2 control	VVVF*2 control
Group control system		Relay			Microcomputer	Microcomputer
Power consumption / CO ₂ emissions*3	for High speed for Low speed	OS-2100	OS-2100C	AI-2100	AI-2100N	ΣAI-2200C
		100%	95%	72%	62%	57%
		100%	93%	74%	37%	54%
						30%
						Approx. -46%
						Approx. -70%

Notes:
*1: Alternative current, variable voltage
*2: Variable voltage, variable frequency
*3: CO₂ emissions in this table are from elevator operation and do not include emissions from manufacturing, transportation and other processes.

Improving operational efficiency

Our ingenious features minimize door open time and reduce passenger waiting time, elevating traffic performance and mitigating passenger frustration.

Strategic Overall Spotting [SOHS]*5 (Standard)

Cars that have finished service are dispersed to stand by at floors where they can respond to predicted future hall calls as quickly as possible so as not to keep passengers waiting for long.

Main Floor Parking [MFP]*5 (Optional)

One of the available cars in a group stands by for a hall call at the lobby (main) floor.

Elevator Group Control Systems [ΣAI-22 and ΣAI-2200C]

Our group control systems use the latest artificial intelligence (AI) technologies to evaluate not only actual waiting time, but also psychological waiting time through assessment of the probability of full-load bypass, prediction errors, etc. for optimum car allocation.

ΣAI-2200C Performance



Note: Simulated with 6 cars, 20 persons each at 2.5m/sec for 15 stops.

Better usability

A large variety of convenient features makes our elevators truly easy to use for everyone.

False Call Cancelling — Call Button Type [FCC-P]*5 (Standard)

If a passenger has pressed a wrong button in the car, it can be cancelled by double-pressing the button.

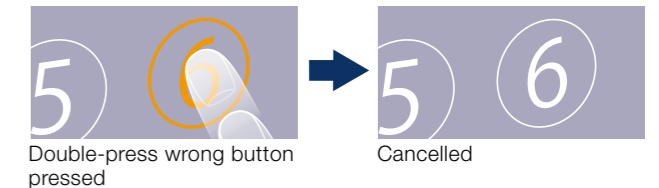

Car Arrival Chime [AECC for car/AECH for hall]*5 (Optional)

Electric chimes on the top and bottom of the car or in each hall sound to indicate that a car will soon arrive.

Reopen with Hall Button [ROHB]*5 (Standard)

Closing doors can be reopened by pressing the hall button corresponding to the traveling direction of the car.

Energy conservation through LED indicators

Choosing a signal fixture with LED indicator to replace an incandescent light indicator is one way to reduce energy consumption.

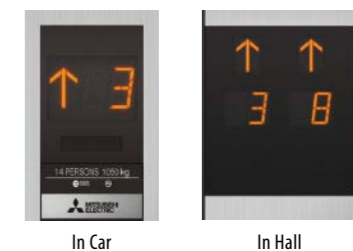

Energy conservation through operational and service features

Car Fan Shut Off — Automatic [CFO-A]*5 (Standard)

Car Light Shut Off — Automatic [CLO-A]*5 (Standard)

The car ventilation fan or lighting is automatically turned off if there are no calls for a specified period.

Regenerative Converter [PCNV] (High speed: Standard, Low speed: Optional)

The Regenerative Converter transmits the power regenerated by the traction machine via the distribution transformer to the electrical network for use in lights, air conditioners and other building facilities.

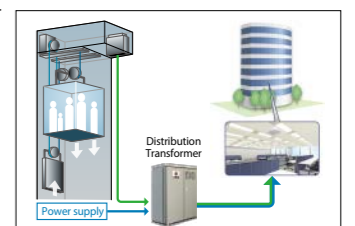

Notes: *4: The described effects may not be realized, depending on your elevator specifications.
*5: The feature may be installed in the elevator which is currently in use. Please refer to pages 17 to 20 for other features.

Replacement of Signal Fixtures*1

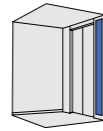

Car operating panels in front return panel

New Design



Standard^{*2}
Segment LED indicator^{*5}
CBV ■^{*7}-C710
(CBV ■^{*7}-C716)^{*8}

Dot LED indicator
CBV ■^{*7}-C720
(CBV ■^{*7}-C726)^{*8}

LCD indicator
CBV ■^{*7}-C730
(CBV ■^{*7}-C736)^{*8}

EN81-20/50:2014-compliant indicator^{*10}

Standard^{*3}
Segment LED indicator^{*5}
CBU ■^{*7}-C710^{*9}
(CBU ■^{*7}-C716)^{*8,9}

Standard^{*3}
Segment LED indicator^{*5}
CBV ■^{*7}-C760
(CBV ■^{*7}-C766)^{*8}

LCD indicator with keypad type
CBVF-C258^{*9}

[Short panel ^{*4,5}]
Standard^{*3}
Segment LED indicator^{*5}
CBV ■^{*7}-C760
(CBV ■^{*7}-C766)^{*8}

Buttons accented with LED illumination

Tactile and flat buttons (stainless-steel with non-directional hairline-finish) are available in three halo illumination colors: yellow-orange, white and blue.

CBV ■ / PIV ■ / HBV ■

Standard

Yellow-orange Tactile button ■ ^{*7} : 1	White Tactile button ■ ^{*7} : 3	Blue Tactile button ■ ^{*7} : 5
Yellow-orange Flat button ■ ^{*7} : 2	White Flat button ■ ^{*7} : 4	Blue Flat button ■ ^{*7} : 6

CBU ■

Yellow-orange Flat button ■ ^{*7} : 2	White Flat button ■ ^{*7} : 4	Blue Flat button ■ ^{*7} : 6
--	--	---

CBN ■^{*5} / HBN ■

Yellow-orange Flat button ■ ^{*7} : 2	White Flat button ■ ^{*7} : 4	Blue Flat button ■ ^{*7} : 6
--	--	---

Square buttons are also available as optional for some car and hall signal fixtures; however some conditions apply. Please consult our local agents for details. The entire button, excluding the characters, is illuminated yellow-orange, white or blue.

Mounting operating panel on side wall

Some latest codes and regulations demand that a car operating panel be mounted on the car side wall. We offer panels for side-wall mount as well as those for front-return-panel mount. However, some conditions apply, including additional side-wall installation. Please consult our local agents.



- Notes:
- *1: If you require design complying with EN81-70, please consult our local agents.
 - *2: Standard for elevators complying with EN81-20/50
 - *3: Standard for elevators which do not need to comply with EN81-20/50
 - *4: This car operating panel is applicable when the number of floors is 22 or less.
 - *5: Not applicable to EN81-20/50 compliant elevators.
 - *6: Segment LED indicators cannot display some letters of the alphabet. Please consult our local agents for details.
 - *7: Please select a button type, and enter the number in ■.
 - *8: The type in parentheses () shows an auxiliary car operating panel (optional). The design is slightly different from the above images. Please consult our local agents for further information such as installation location.
 - *9: Applicability may vary depending on conditions.
 - *10: The indicator will be incorporated in car operating panels for EN81-20/50:2014-compliant elevators.

New Design

Replacement of Signal Fixtures*1

Hall position indicators and buttons

All fixtures shown, even standard type have the faceplate made of hairline-finished stainless steel.

Segment LED indicator*2,3 with plastic case



Standard PIV ■*4-A1010 PIV ■*4-A1020
OP: Surface Mount OP: Surface Mount

Segment LED indicator*2



PIV ■*4-C710*5 PIV ■*4-C720*5

These fixtures come with solutions to erase the vestige of old fixtures with minimum construction work, as introduced on the opposite page.

Dot LED indicator



PIV ■*4-C730*5 PIV ■*4-C740*5

LCD indicator



PIV ■*4-C766*5,6 PIV ■*4-C776*5,6

These fixtures come with solutions to erase the vestige of old fixtures with minimum construction work, as introduced on the opposite page.

Hall buttons (Optional)

with plastic case



HBV ■*4-A1010 HBV ■*4-C710*5
OP: Surface Mount

These fixtures come with solutions to erase the vestige of old fixtures with minimum construction work, as introduced on the opposite page.

Hall position indicators (Optional)



PIH-D424A (Segment LED indicator*2,7) OP: Surface Mount



PIH-D423A (Dot LED indicator*2,8) OP: Surface Mount



PIH-D417 (Segment LED indicator*2)

Hall lanterns (Optional)



HLV-A16*10



HLH-A16*10



HLV-A21



HLV-A31



HLV-E65



HLV-E66



HLV-E71



HLH-A31

Hall position indicator with lantern (Optional)



PIE-B47 (Segment LED indicator*2,3)

LCD position indicator (Optional)



PIH-C117 (5.7-inch)

LCD information displays (Optional)



PIH-C216 (10.4-inch)*9



PIH-C226 (15-inch)*9

OP: Surface Mount

This mark indicates that the surface-mount type is available as optional.

Cross-section of surface-mount fixtures

These hall signal fixtures can be easily mounted on the wall surface without having to cut into the wall to embed the back box.

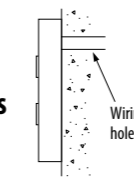

Notes:

- *1: If you require design complying with EN81-70, please consult our local agents.
- *2: Segment LED indicators cannot display some letters of the alphabet. Please consult our local agents for details.
- *3: Dot LED indicators are available (optional). Please consult our local agents for details.
- *4: Please select a button type on page 10, and enter the number in ■.
- *5: Faceplates with stainless-steel, mirror-finish are also available (optional). Please consult our local agents for details.
- *6: Please consult our local agents for the production terms, etc.
- *7: Dot LED indicator is available as PIH-D422A.
- *8: Segment LED indicator is available as PIH-D425A.
- *9: Elevator status messages and video images can be displayed.
- *10: Depending on the conditions, incandescent lights may be used instead of LED.

Effectively conceals existing mounting holes

We cater to the need of replacing hall signal fixtures without leaving a trace of the previous installation, even when the fixtures are different sizes.



Innovative Technology

Introducing sophisticated operation systems enhances comfort, mobility and building security.



More Efficient, More Comfort

•Destination Oriented Allocation System [DOAS] (Optional)

Passengers register their destination floor using a hall operating panel before entering the elevator, eliminating the need to press the button inside the car. Furthermore, dispersing passengers by destination prevents congestion in cars and minimizes waiting and travel time.

■ Evaluating travel time

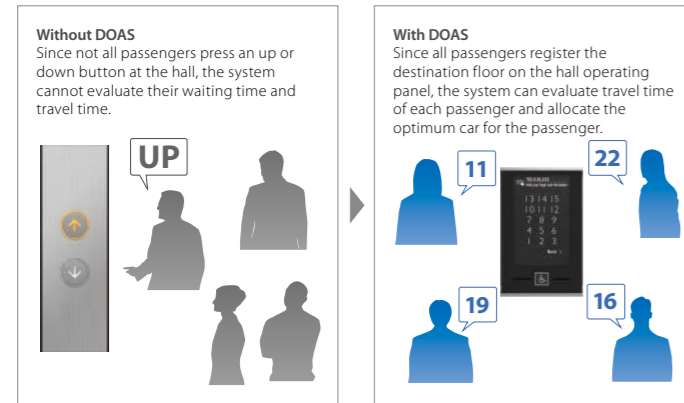

■ Reducing travel time

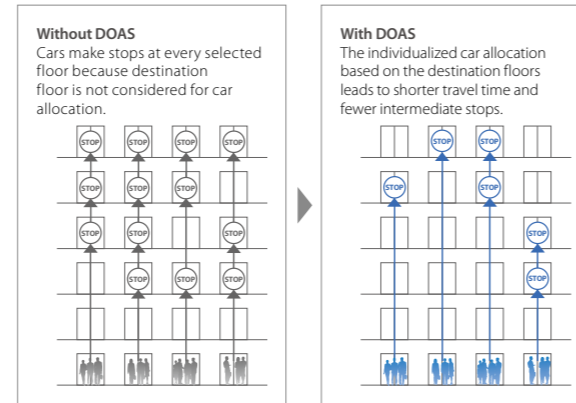

■ Passenger support features (Car selection)

This function enables passengers, especially those who have difficulty with mobility or require space such as wheelchair users, to specify the closest or relatively uncrowded car using the panel screen.

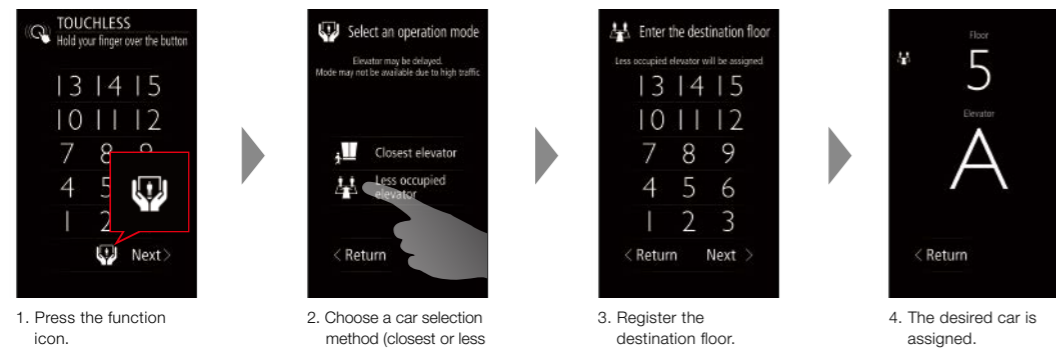

More Security

•DOAS Integrated with Security Gate [EL-SCA] (Optional)

Extended feature for more security

The destination floor can be registered automatically after passing a card over a card reader at the security gate entrance. DOAS integrated with security gates provides a seamless journey and enhances security in the building. By eliminating the need to touch a call button in the elevator lobby or car, the system provides increased convenience and comfort to users.



Without DOAS

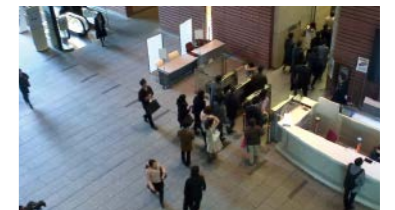

With DOAS integrated with security gate

More Closely Connected

•Elevator Call System with Smartphone [ELCS-SP] (Optional)

Users can call an elevator remotely by accessing a dedicated website with a smartphone.

By eliminating the need to touch a call button in the elevator lobby or car, the system provides increased convenience and comfort to users.



MelEye

MelEye is a sophisticated Web-based elevator and escalator monitoring and control system that allows authorized personnel to respond rapidly to changing traffic patterns and other operational conditions. It improves passenger safety and reliability of your building management.

User-friendly screens



Operational failures and errors will be highlighted for easier recognition on the screen and to improve rapid troubleshooting.



Signal Fixtures for DOAS (Optional)¹

•Hall operating panels

10.1-inch touchless screen

With Audio guidance



HSP-A21N

With card reader²
+ Audio guidance



HSP-A26N

Pedestal type

With pedestal is available as optional. Please consult our local agents for details.



HSP-P21M / HSP-P26M
(With card reader)

Keypad

■ Dot LED display

With Audio guidance



HSVF-C232

With card reader²
+ Audio guidance



HSVF-C233

■ 5.7-inch LCD display

With Audio guidance



HSVF-C274

With card reader²
+ Audio guidance



HSVF-C285

10.1-inch touchscreen

With Audio guidance



HSP-C13A

With card reader²
+ Audio guidance



HSP-C18A

•Hall lantern with elevator number plate



HLV-E1165

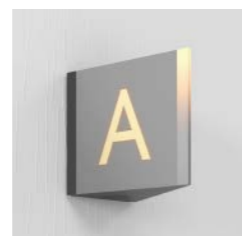

HLF-A10
HLF-A11 (With chime)

•Car operating panel with destination floor indicator



CBU2-C739

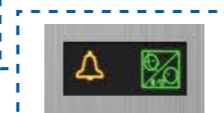

EN81-20/50:2014-compliant indicator

Other Major Features

In addition to features already described, a wide variety of convenient features is available.

Standard Features

For increasing security

•Power-On Releveling [PORL]

Before the car parking at a door zone due to power failure resumes the operation and opens the doors, the level difference between the car floor and the landing is automatically adjusted to prevent the passengers from stumbling and falling.

•Safe Landing [SFL]^{*1}

If a car has stopped between floors due to some equipment malfunction, the controller checks the cause, and if it is considered safe to move the car, the car will move to the nearest floor at a low speed and the doors will open.

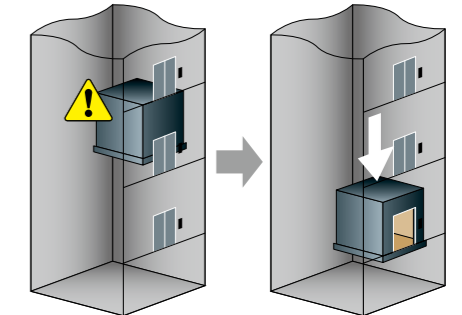

SFL image

For safer door operation

•Next Landing [NXL]^{*1}

If the elevator doors do not open fully at a destination floor, the doors close, and the car automatically moves to the next or nearest floor where the doors open.

•Door Sensor Self-diagnosis [DODA]

Failure of non-contact door sensors is checked automatically, and if a problem is diagnosed, the door-close timing is delayed and the closing speed is reduced to maintain elevator service and ensure passenger safety.

•Automatic Door Speed Control [DSAC]

Door load on each floor, which can depend on the type of hall doors, is monitored to adjust the door speed, thereby making the door speed consistent throughout all floors. (Cannot be used with some doors.)

•Door Nudging Feature – With Buzzer [NDG]^{*1}

A buzzer sounds and the doors slowly close when they have remained open for longer than the preset period.

Optional Features

For safety in case of emergency

•Mitsubishi Emergency Landing Device [MELD]^{*1}

Upon power failure, a car equipped with this function automatically moves and stops at the nearest floor using a rechargeable battery, and the doors open to facilitate the safe evacuation of passengers.

•Earthquake Emergency Return [EER-S/P]^{*1}

Upon activation of primary and/or secondary wave seismic sensors, all cars stop at the nearest floor, and park there with the doors open to facilitate the safe evacuation of passengers.

•Fire Emergency Return [FER] (FER operation Signal Lamp in Car [FERC]^{*1})

Upon activation of a key switch or a building's fire alarm, all calls are canceled, all cars immediately return to a specified evacuation floor and the doors open to facilitate the safe evacuation of passengers. The indicator, when incorporated in the car operating panel, illuminates to show that the car is in fire emergency operation. [FERC] (Optional)

•Overload Holding Stop [OLH] & Overload Holding Stop Light (Car) [OLHL]^{*1,*2}

A buzzer sounds to alert the passengers that the car is overloaded. The doors remain open and the car will not leave that floor until enough passengers exit the car. [OLH] The indicator, when incorporated in the car operating panel, illuminates to show that the car is overloaded. [OLHL]

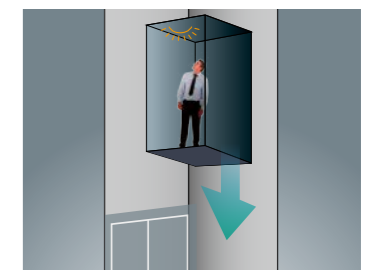

MELD image



OLHL image

For further convenience

•Mitsubishi Elevators & Escalators Monitoring and Control System – MeEye [WP-W]

Each elevator's status and operation can be monitored and controlled using an advanced Web-based technology which provides an interface through personal computers. Special optional features such as preparation of traffic statistics and analysis are also available.

•Non-service Temporary Release for Car Call (Card Reader Type) [NSCR-C]

Non-Service to Specific Floors can be temporarily released by swiping a card through the car operating panel.



MeEye image

NSCR-C image

Notes:

*1: If you require design complying with EN81-70, please consult our local agents.

*2: Card reader is to be supplied by customer. Please consult our local agents for details.

Notes:

*1: The feature may be installed in the elevator which is currently in use. Please refer to pages 17 to 20 for other features.

*2: The feature becomes a standard feature where EN81-20/50 applies.

Features 1/2

Feature	Abbreviation	Description	For low speed			For high speed		
			1C to 2C 2BC	3C to 4C EAI-22	3C to 8C EAI-2200C	1C to 2C 2BC	3C to 4C EAI-22	3C to 8C EAI-2200C
EMERGENCY OPERATIONS AND FEATURES								
Building Management System — Gateway	BMS-GW	Each elevator's status and operation can be monitored and controlled using a building management system which manages various facilities in the building via the interface for the elevator system through serial communication.	○	○	○	○	○	○
Contact Supply for Elevator State Signal for BA/BMS	CSB	Each elevator's status and operation can be monitored and controlled using a building management system which manages various facilities in the building via the interface for the elevator system through parallel communication.	○	○	○	○	○	○
Earthquake Emergency Return	EER-P EER-S	Upon activation of primary and/or secondary wave seismic sensors, all cars stop at the nearest floor, and park there with the doors open to facilitate the safe evacuation of passengers.	○	○	○	○	○	○
Emergency Car Lighting	ECL	Car lighting which turns on immediately when power fails, providing a minimum level of lighting within the car. (Choice of dry-cell battery or trickle-charge battery.)	○	○	○	○	○	○
Fire Emergency Return	FER	Upon activation of a key switch or a building's fire alarm, all calls are canceled, all cars immediately return to a specified evacuation floor and the doors open to facilitate the safe evacuation of passengers. The indicator, when incorporated in the car operating panel, illuminates to show that the car is in fire emergency operation. [FERC] (Optional)	○	○	○	○	○	○
Firefighters' Emergency Operation	FE	During a fire, when the fire operation switch is activated, the car calls of a specified car and all hall calls are canceled and the car immediately returns to a predetermined floor. The car then responds only to car calls which facilitate firefighting and rescue operation. The indicator, when incorporated in the car operating panel or hall position indicator, illuminates to show that the car is in firefighters' emergency operation. [Car: FELC, Hall, FELH] (Optional)	○	○	○	○	○	○
MelEye Mitsubishi Elevators & Escalators Monitoring and Control System	WP-W	Each elevator's status and operation can be monitored and controlled using an advanced Web-based technology which provides an interface through personal computers. Special optional features such as preparation of traffic statistics and analysis are also available.	○	○	○	○	○	○
Mitsubishi Emergency Landing Device	MELD	Upon power failure, a car equipped with this function automatically moves and stops at the nearest floor using a rechargeable battery, and the doors open to facilitate the safe evacuation of passengers. (Please consult our local agents regarding a rechargeable batteries and maximum allowable floor-to-floor distance.)	○	○	○	○	○	○
Operation by Emergency Power Source — Automatic / Manual	OEPS	Upon power failure, predetermined car(s) uses the building's emergency power supply to move to a specified floor, where the doors then open to facilitate the safe evacuation of passengers. After all cars have arrived, predetermined cars resume normal operation.	○	○	○	○	○	○
Supervisory Panel	WP	Each elevator's status and operation can be remotely monitored and controlled through a panel installed in a building's supervisory room, etc.	○ ^{#1}	○ ^{#1}	○ ^{#1}	○ ^{#1}	○ ^{#1}	○ ^{#1}

DOOR OPERATION FEATURES

Automatic Door-open Time Adjustment	DOT	The amount of time that doors are open will automatically be adjusted depending on whether the stop was called from the hall or the car, to allow smooth boarding of passengers or loading of baggage.	-	-	○	-	-	○
Automatic Door Speed Control	DSAC	Door load on each floor, which can depend on the type of hall doors, is monitored to adjust the door speed, thereby making the door speed consistent throughout all floors. (Cannot be used with some doors.)	○	○	○	○	○	○
Door Load Detector	DLD	When excessive door load has been detected while opening or closing, the doors immediately reverse.	○	○	○	○	○	○
Door Nudging Feature — With Buzzer	NDG	A buzzer sounds and the doors slowly close when they have remained open for longer than the preset period. With the AAN-B or AAN-G feature, a beep and voice guidance sound instead of the buzzer.	○	○	○	○	○	○
Door Sensor Self-diagnosis	DODA	Failure of non-contact door sensors is checked automatically, and if a problem is diagnosed, the door-close timing is delayed and the closing speed is reduced to maintain elevator service and ensure passenger safety.	○	○	○	○	○	○
Electronic Doorman	EDM	Door open time is minimized using the Multi-beam Door Sensor feature that detects passengers boarding or exiting.	○	○	○	○	○	○
Extended Door-open Button	DKO-TB	When the button inside a car is pressed, the doors will remain open longer to allow loading and unloading of baggage, a stretcher, etc.	○	○	-	○	○	-
Hall Motion Sensor	HMS	Infrared-light is used to scan a 3D area near the open doors to detect passengers or objects.	○ ^{#1}	○ ^{#1}	○ ^{#1}	○ ^{#1}	○ ^{#1}	○ ^{#1}
Multi-beam Door Sensor	-	Multiple infrared-light beams cover some height of the doors to detect passengers or objects as the doors close.	○ ^{#1,2,3}	○ ^{#1,2,3}	○ ^{#1,2,3}	○ ^{#1,2,3}	○ ^{#1,2,3}	○ ^{#1,2,3}
Reopen with Hall Button	ROHB	Closing doors can be reopened by pressing the hall button corresponding to the traveling direction of the car.	○	○	○	○	○	○
Repeated Door-close	RDC	Should an obstacle prevent the doors from closing, the doors will repeatedly open and close until the obstacle is cleared from the doorway.	○	○	○	○	○	○
Safety Door Edge	SDE	The sensitive door edge detects passengers or objects during door closing.	○ ^{#4}	○ ^{#4}	○ ^{#4}	○ ^{#4}	○ ^{#4}	○ ^{#4}

OPERATIONAL AND SERVICE FEATURES

Apartment Service	MES	In residential buildings, to reduce passenger waiting time, the floor where elevators wait on standby can be set according to the time zone; for instance, an intermediate floor during morning down-peak and a lobby floor during evening up-peak hours. (The Apartment Service is not applicable to some elevators. Please consult our local agents for details.)	○ [†]	○	-	○ [†]	○	-
Attendant Service	AS	Exclusive operation where an elevator can be operated using the buttons and switches located in the car operating panel, allowing smooth boarding of passengers or loading of baggage.	○	○	○	○	○	○
Automatic Bypass	ABP	A fully-loaded car bypasses hall calls in order to maintain maximum operational efficiency.	○ [☆]	○ [☆]	○	○ ^{#5}	○	○

Feature	Abbreviation	Description	For low speed			For high speed		
			1C to 2C 2BC	3C to 4C EAI-22	3C to 8C EAI-2200C	1C to 2C 2BC	3C to 4C EAI-22	3C to 8C EAI-2200C
OPERATIONAL AND SERVICE FEATURES (Continued from the previous page.)								
Automatic Hall Call Registration	FSAT	If one car cannot carry all waiting passengers because it is full, another car will automatically be assigned for the remaining passengers.	○ [☆]	○ [☆]	○	○	○	○
Backup Operation for Group Control Microprocessor	GCBK	An operation by car controllers which automatically maintains elevator operation in the event that a microprocessor or transmission line in the group controller has failed.	○ [†]	○	○	○ [†]	○	○
Car Call Canceling	CCC	When a car has responded to the final car call in one direction, the system regards remaining calls in the other direction as mistakes and clears them from the memory.	○	○	○	○	○	○
Car Fan Shut Off — Automatic	CFO-A	If there are no calls for a specified period, the car ventilation fan will automatically turn off to conserve energy.	○	○	○	○	○	○
Car Light Shut Off — Automatic	CLO-A	If there are no calls for a specified period, the car lighting will automatically turn off to conserve energy.	○	○	○	○	○	○
Continuity of Service	COS	A car which is experiencing trouble is automatically withdrawn from group control operation to maintain overall group performance.	○ [†]	○	○	○	○	○
Elevator and Security System Interface	EL-SCA/ EL-SC	Personal authentication by building's security devices can trigger predetermined elevator operation such as permission of access to private floors, automatic registration of a hall call and a destination floor, and priority service.	○	○	○	○	○	○
False Call Canceling — Automatic	FCC-A	If the number of registered car calls does not correspond to the car load, all calls are canceled to avoid unnecessary stops.	○ [☆]	○ [☆]	○ [☆]	○	○	○
False Call Canceling — Car Button Type	FCC-P	If a wrong car button is pressed, it can be canceled by quickly pressing the same button again twice.	○ [☆]	○ [☆]	○ [☆]	○	○	○
Going-out Service	GOS	When passengers press the down button in the hall of the floor they live on, the car that answers the call automatically travels down to a predetermined floor without any buttons in the car being pressed. (The Going-out Service is not applicable to some elevators. Please consult our local agents for details.)	○	○	-	○	○	-
High Accuracy Landing Feature	HARL	The car landing level is adjusted to a high level of precision in order to ensure a landing accuracy of ±5mm under any conditions.	-	-	-	○	○	○
Independent Service	IND	Exclusive operation where a car is withdrawn from group control operation for independent use, such as maintenance or repair, and responds only to car calls.	○	○	○	○	○	○
Landing Open	LO	Doors start opening right before the car has completely stopped at a floor.	- [☆]	- [☆]	- [☆]	○	○	○
Motor Drive Mix	MDX	The rate of car acceleration and deceleration is automatically increased according to the car load to reduce passenger waiting and travel time.	-	-	-	-	○ ^{#6}	○ ^{#6}
Next Landing	NXL	If the elevator doors do not open fully at a destination floor, the doors close, and the car automatically moves to the next or nearest floor where the doors open.	○	○	○	○	○	○
Non-service to Specific Floors — Car Button Type	NS-CB	To enhance security, service to specific floors can be disabled using the car operating panel. This function is automatically deactivated during emergency operation.	○	○	○	○	○	○
Non-service Temporary Release for Car Call — Card Reader Type	NSCR-C	To enhance security, car calls for desired floors can be registered only by placing a card over a card reader. This function is automatically deactivated during emergency operations.	○	○	○	○	○	○
Non-service to Specific Floors — Switch Type	NS	To enhance security, service to specific floors can be disabled using a manual switch. This function is automatically deactivated during emergency operation.	○	○	○	○	○	○
Non-service to Specific Floors — Timer Type	NS-T	To enhance security, service to specific floors can be disabled using a timer switch. This function is automatically deactivated during emergency operation.	○	○	○	○	○	○
Out-of-service — Remote	RCS	With a key switch on the supervisory panel, etc., a car can be called to a specified floor after responding to all car calls, and then automatically be taken out of service.	○	○	○	○	○	○
Overload Holding Stop	OLH	A buzzer sounds to alert the passengers that the car is overloaded. The doors remain open and the car will not leave that floor until enough passengers exit the car. The indicator, when incorporated in the car operating panel, illuminates to show that the car is overloaded. [OLHL] (Optional)	○	○	○	○	○	○
Power On Releveling	PORL	In case the car stops in the door zone after stopping suddenly due to power failure, when power is re-supplied after recovering from the power failure, car floor releveling is activated to be located in the same level as landing floor to prevent passengers from tumbling.	○	○	○	○	○	○
Regenerative Converter	PCNV	For energy conservation, power regenerated by a traction machine can be used by other electrical systems in the building. (The Regenerative Converter is not applicable to some elevators. Please consult our local agents for details.)	○ [☆]	○ [☆]	○ [☆]	○	○	○
Return Operation	RET	Using a key switch on the supervisory panel, a car can be withdrawn from group control operation and called to a specified floor. The car will park on that floor with the doors open, and not accept any calls until independent operations begin.	○	○	○	○	○	○
Rope Replacement Alarm	RRA	This self-diagnosis function gives an alert when rope replacement timing has approached.	-	-	-	○	○	○
Safe Landing	SFL	If a car has stopped between floors due to some equipment malfunction, the controller checks the cause, and if it is considered safe to move the car, the car will move to the nearest floor at a low speed and the doors will open.	○	○	○	○	○	○
Secret Call Service	SCS-B	To enhance security, car calls for desired floors can be registered only by entering secret codes using the car buttons on the car operating panel. This function is automatically deactivated during emergency operation. (This feature is applicable only to car operating panels with a service cabinet.)	○	○	○	○	○	○

Features 2/2

Feature	Abbreviation	Description	For low speed			For high speed		
			1C to 2C 2BC	3C to 4C ΣAI-22	3C to 8C ΣAI-2200C	1C to 2C 2BC	3C to 4C ΣAI-22	3C to 8C ΣAI-2200C
GROUP CONTROL FEATURES								
Bank-separation Operation	BSO	Hall buttons and the cars called by each button can be divided into several groups for independent group control operation to serve special needs or different floors.	⊕ [†]	⊙	⊙	⊕ [†]	⊙	⊙
Car Allocation Tuning	CAT	The number of cars allocated or parked on crowded floors is controlled not just according to the conditions on those crowded floors but also the operational status of each car and the traffic on each floor.	-	-	Ⓢ	-	-	Ⓢ
Car Travel Time Evaluation	-	Cars are allocated to hall calls by considering the number of car calls that will reduce passenger waiting time in each hall and the travel time of each car.	-	Ⓢ	Ⓢ	-	Ⓢ	Ⓢ
Closest-car Priority Service	CNPS	A function to give priority allocation to the car closest to the floor where a hall call button has been pressed, or to reverse the closing doors of the car closest to the pressed hall call button on that floor. (Cannot be combined with hall position indicators.)	-	⊙ ^{#1}	⊙	-	⊙ ^{#1}	⊙
Congested-floor Service	CFS	The timing of car allocation and the number of cars to be allocated to floors where meeting rooms or ballrooms exist and the traffic intensifies for short periods of time are controlled according to the detected traffic density data for those floors.	-	⊙	⊙	-	⊙	⊙
Cooperative Optimization Assignment	-	The system predicts a potential hall call which could cause longer waiting time. Car assignment is performed considering not only current and new calls but also near-future calls.	-	-	Ⓢ	-	-	Ⓢ
Destination Oriented Allocation System	DOAS	When a passenger enters a destination floor at a hall, the hall operating panel indicates which car will serve the floor. The passenger does not need to press a button in the car. Dispersing passengers by destination prevents congestion in the cars and minimizes waiting and traveling time. (Cannot be combined with some features. Please consult our local agents for details.)	-	-	⊙ ^{#2}	-	-	⊙ ^{#2}
Distinction of Traffic Flow with Neural Networks	NN	Traffic flows in a building are constantly monitored using neural network technology, and the optimum operational pattern for the LTS, UPS feature, etc. is selected or canceled accordingly at the appropriate time.	-	-	Ⓢ	-	-	Ⓢ
Down Peak Service	DPS	Controls the number of cars to be allocated and the timing of car allocation in order to meet increased demands for downward travel during office leaving time, hotel check-out time, etc. to minimize passenger waiting time.	-	⊙	⊙	-	⊙	⊙
Dynamic Rule-set Optimizer	DRO	Traffic flows in a building are constantly predicted using neural network technology, and an optimum rule-set for group control operations is selected through real-time simulations based on prediction results.	-	-	Ⓢ	-	-	Ⓢ
Elevator Call System with Smartphone	ELCS-SP	Users can call an elevator remotely by accessing a dedicated website with a smartphone. By eliminating the need to touch a call button in the elevator lobby or car, the system provides increased convenience and comfort to users.	⊙ ^{#1}	⊙ ^{#1}	⊙ ^{#1}	⊙ ^{#1}	⊙ ^{#1}	⊙ ^{#1}
Energy-saving Operation—Allocation Control	ESO-W	The system selects the elevator that best balances operational efficiency and energy consumption according to each elevator's current location and passenger load as well as predicted congestion levels throughout the day.	-	-	Ⓢ	-	-	Ⓢ
Energy-saving Operation—Number of Cars	ESO-N	To save energy, the number of service cars is automatically reduced to some extent but not so much as to adversely affect passenger waiting time.	-	⊙	Ⓢ	-	-	-
Energy-saving Operation—Power Reduction during Off-peak	ESO-A	To save energy, some elevators are automatically put into sleep mode if there are no calls for a specified period.	-	-	-	⊕ [†]	⊙	Ⓢ
Energy-saving Operation—Speed Control	ESO-V	To save energy, the car speed is automatically reduced to some extent, but not so much that it adversely affects passenger waiting time.	-	-	-	-	⊙	⊙
Expert System and Fuzzy Logic	-	Artificial expert knowledge, which has been programmed using "expert system" and "fuzzy logic", is applied to select the ideal operational rule which maximizes the efficiency of group control operations.	-	Ⓢ	Ⓢ	-	Ⓢ	Ⓢ
Forced Floor Stop	FFS	All cars in a bank automatically make a stop at a predetermined floor on every trip without being called.	⊙	⊙	⊙	⊙	⊙	⊙
Intense Up Peak	IUP	To maximize transport efficiency, an elevator bank is divided into two groups of cars to serve upper and lower floors separately during up peak. In addition, the number of cars to be allocated, the timing of car allocation to the lobby floor, the timing of door closing, etc. are controlled based on predicted traffic data.	-	-	⊙	-	-	⊙
Light-load Car Priority Service	UCPS	When traffic is light, empty or lightly-loaded cars are given higher priority to respond to hall calls in order to minimize passenger travel time. (Cannot be combined with hall position indicators.)	-	⊙ ^{#1}	⊙	-	⊙ ^{#1}	⊙
Lunchtime Service	LTS	During the first half of lunchtime, calls for a restaurant floor are served with higher priority, and during the latter half, the number of cars allocated to the restaurant floor, the allocation timing for each car and the door opening and closing timing are all controlled based on predicted data.	-	⊙	⊙	-	⊙	⊙
Main Floor Changeover Operation	TFS	This feature is effective for buildings with two main (lobby) floors. The floor designated as the "main floor" in a group control operation can be changed as necessary using a manual switch.	⊙	⊙	⊙	⊙	⊙	⊙
Main Floor Parking	MFP	An available car always parks on the main (lobby) floor with the doors open.	⊙	⊙	⊙	⊙	⊙	⊙
Peak Traffic Control	PTC	A floor which temporarily has the heaviest traffic is served with higher priority over other floors, but not to the extent that it interferes with the service to other floors.	-	Ⓢ	Ⓢ	-	Ⓢ	Ⓢ
Psychological Waiting Time Evaluation	-	Cars are allocated according to the predicted psychological waiting time for each hall call. The rules evaluating psychological waiting time are automatically changed in a timely manner in response to actual service conditions.	-	Ⓢ	Ⓢ	-	Ⓢ	Ⓢ
Special Car Priority Service	SCPS	Special cars, such as observation elevators and elevators with basement service, are given higher priority to respond to hall calls. (Cannot be combined with hall position indicators.)	-	⊙ ^{#1}	⊙	-	⊙ ^{#1}	⊙
Special Floor Priority Service	SFPS	Special floors, such as floors with VIP rooms or executive rooms, are given higher priority for car allocation when a call is made on those floors. (Cannot be combined with hall position indicators.)	-	⊙ ^{#1}	⊙	-	⊙ ^{#1}	⊙
Strategic Overall Spotting	SOHS	To reduce passenger waiting time, cars which have finished service are automatically directed to positions where they can respond to predicted hall calls as quickly as possible.	Ⓢ [†]	Ⓢ	Ⓢ	Ⓢ [†]	Ⓢ	Ⓢ
Up Peak Service	UPS	Controls the number of cars to be allocated to the lobby floor, as well as the car allocation timing, in order to meet increased demands for upward travel from the lobby floor during office starting time, hotel check-in time, etc., and minimize passenger waiting time.	-	⊙	⊙	-	⊙	⊙
VIP Operation	VIP-S	A specified car is withdrawn from group control operation for VIP service operation. When activated, the car responds only to existing car calls, moves to a specified floor and parks there with the doors open. The car then responds only to car calls.	⊕ [†]	⊙	⊙	⊕ [†]	⊙	⊙

Feature	Abbreviation	Description	For low speed			For high speed		
			1C to 2C 2BC	3C to 4C ΣAI-22	3C to 8C ΣAI-2200C	1C to 2C 2BC	3C to 4C ΣAI-22	3C to 8C ΣAI-2200C
SIGNAL AND DISPLAY FEATURES								
Auxiliary Car Operating Panel	ACS	An additional car control panel which can be installed for large-capacity elevators, heavy-traffic elevators, etc.	⊙ [☆]	⊙ [☆]	⊙ [☆]	⊙ [☆]	⊙ [☆]	⊙ [☆]
Basic Announcement	AAN-B	A synthetic voice (and/or buzzer) alerts passengers inside a car that elevator operation has been temporarily interrupted by overloading or a similar cause. (Available in limited languages.)	⊙ [☆]	⊙ [☆]	⊙ [☆]	Ⓢ	Ⓢ	Ⓢ
Car Arrival Chime	AECC	Electronic chimes sound to indicate that a car will soon arrive. (The chimes are mounted either on the top and bottom of the car, or in each hall.)	⊙	⊙	- ^{#2}	⊙	⊙	- ^{#2}
	AECH		⊙	⊙	Ⓢ	⊙	⊙	Ⓢ
Car LCD Position Indicator	CID-S	This 5.7-inch LCD for car operating panels shows the date and time, car position, travel direction and elevator status messages.	⊙	⊙	⊙	⊙	⊙	⊙
Flashing Hall Lantern	FHL	A hall lantern, which corresponds to a car's service direction, flashes to indicate that the car will soon arrive.	⊙	⊙	Ⓢ	⊙	⊙	Ⓢ
Hall LCD Position Indicator	HID-S	This 5.7-inch LCD for elevator halls shows the date and time, car position, travel direction and elevator status messages. A hall lantern, which corresponds to a car's service direction, flashes to indicate that the car will soon arrive.	⊙	⊙	-	⊙	⊙	-
Immediate Prediction Indication	AIL	When a passenger has registered a hall call, the best car to respond to that call is immediately selected, the corresponding hall lantern lights up and a chime sounds once to indicate which doors will open.	-	-	⊙	-	-	⊙
Intercommunication System	ITP	A system which allows communication between passengers inside a car and the building personnel.	⊙	⊙	⊙	⊙	⊙	⊙
Second Car Prediction	TCP	When a hall is crowded to the extent that one car cannot accommodate all waiting passengers, the hall lantern of the next car to serve the hall will light up.	-	-	⊙	-	-	⊙
Sonic Car Button—Click Type	ACB	A click-type car button which emits electronic beep sounds when pressed to indicate that the call has been registered.	⊙	⊙	⊙	⊙	⊙	⊙
Voice Guidance System	AAN-G	Information on elevator service such as the current floor or service direction is given to the passengers inside a car. (Available in limited languages.)	⊙	⊙	⊙	⊙	⊙	⊙

Notes: 1C-2BC (1-car selective collective) – Standard, 2C-2BC (2-car group control system) – Optional
 ΣAI-22 (3- to 4-car group control system) – Optional, ΣAI-2200C (3- to 8-car group control system) – Optional
 Ⓢ = Standard ⊙ = Optional † = Not applicable to 1C-2BC - = Not applicable
 ☆ = Applicability of the feature may vary depending on conditions.
 #1: Please consult our local agents for the production terms, etc.
 #2: • When DOAS is applied, AECC is ⊙ and Multi-beam Door Sensor feature is required.
 • DOAS cannot be combined with some features. Please refer to the ΣAI-2200C brochure for details.
 #3: Standard when compliance with EN 81-20/50 is required.
 #4: Optional when compliance with EN 81-20/50 is required.
 #5: Optional when the operation system is 1C-2BC.
 #6: Applicable only if the entire traction machine is replaced. Please consult our local agents for details.

Other information

Components Replaced

ELEMOTION offers replacement of major components (page 4) and their subsidiary components as shown in the right table.





Major components replaced (refer to page 4 for image)		Major subsidiary components replaced
Mechanical	① Traction machine	Hoisting rope
Electrical	② Control panel	Traveling cable, landing device car station, intercom
	③ Door motor	
	④ Various signal fixtures	

Modernization Menu*

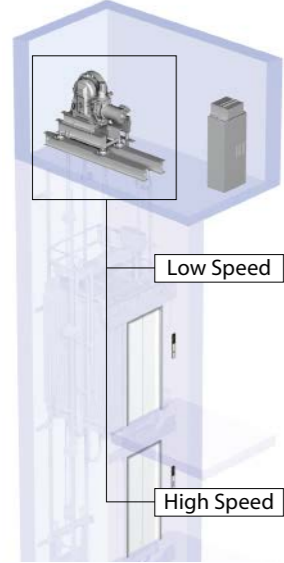
Regarding traction machine ① in particular, replacement components within budget can be chosen from the three options in the modernization menu shown in the table below.

Replacing parts are colored orange area.

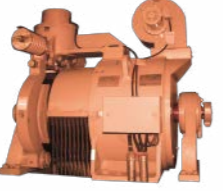

	Most recommended proposal	Other proposals	
	CM2: Replacing the entire traction machine	CM1: Replacing electrical components (motor, encoder, etc.) of the traction machine	CM0: Retaining the traction machine (replacing only some components (encoder, etc.))
Low Speed			
High Speed		/	
			

The modernization effects on energy saving and other aspects introduced in this brochure vary depending on components replaced. Please consult our local agent for details.

Note:

* This modernization menu may not be applicable depending on the specifications and state of the elevator currently in use. Please consult our local agent for details.

Application (The scope of application varies depending on the specifications of the elevator currently in use.)

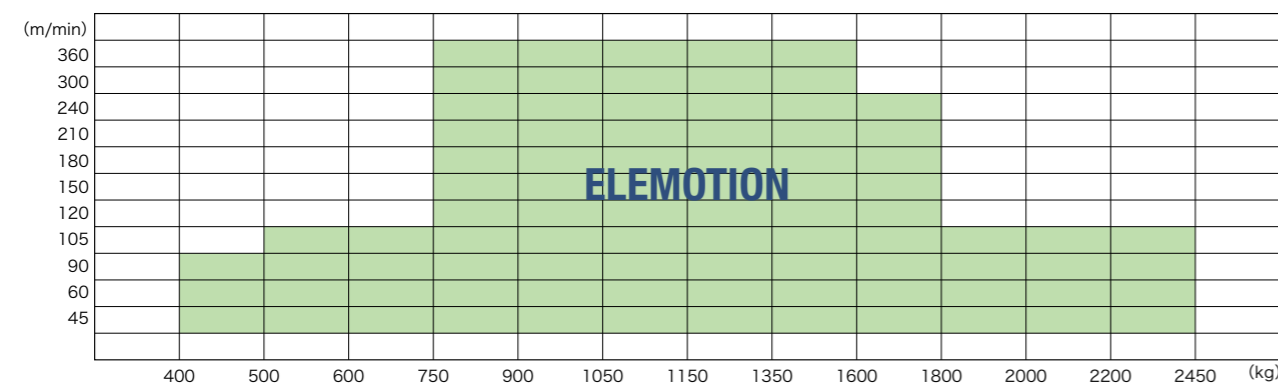

※ Contact our local sales agent to check your elevator type; high speed or low speed.

Work Not Included in Basic Elevator Contract

The following items are excluded from our elevator modernization work, and are therefore the responsibility of the building owner or general contractor.

Elevator Halls and Hoistways

1. Finishing of walls and floors of elevator halls after installation of elevator hall fittings.
2. Hoistway repair work.
3. Installing intermediate beams (where existing ones cannot be used).
4. Drilling holes for jambs and transom panels, hall indicators, hall buttons, etc., in the entrance halls on each floor (where existing ones cannot be used).
5. Installing steel backing plates for the jambs and transom panels, hall buttons, hall indicators, etc., in the entrance halls on each floor where steel-frame construction is used (where existing ones cannot be used).
6. Installing fasteners for the mounting of rail brackets on floors where steel-frame construction is used (where existing ones cannot be used).

Machine Rooms

1. Removing the machine-room floor (breaking up cinder concrete).
2. Laying conduits in the machine-room floor before laying and finishing cinder concrete.
3. Drilling holes in the machine-room floor.
4. Providing a temporary opening to bring in machinery and perform restoration work.
5. Access to the elevator machine room sufficient to allow passage for transporting machinery from outside the building.

Temporary Installation Work

1. Disposing of removed parts, cleaning up and disposing of broken glass and scrap.
2. Providing a suitable, locked space for storage of removed or to-be-installed elevator parts and tools.
3. Supplying electric power for the work and lighting.

Cautions Regarding Installation Work

1. Temporary hall enclosures should be provided.
2. A certain amount of vibration and noise is inevitable during the installation period.
3. Flammable materials are used during the installation period.
4. Security guards should be deployed throughout the installation period.

* Work responsibilities in installation and construction shall be determined according to the local laws. Please consult our local agents for details.

Our elevators, escalators and building management systems are always evolving, helping achieve our goal of being the No.1 brand in quality.

In order to satisfy customers in all aspects of comfort, efficiency and safety while realizing a sustainable society, quality must be of the highest level in all products and business activities, while priority is place on consideration for the environment. As the times change, we promise to utilize the collective strengths of its advanced and environmental technologies to offer its customers safe and reliable products while contributing to society.



We strive to be green in all of our business activities.

We take every action to reduce environmental burden during each process of our elevators' and escalators' lifecycle.



ELEVATORS & ESCALATORS GREEN TECHNOLOGIES

* Quality in Motion is a trademark of Mitsubishi Electric Corporation.



State-of-the-Art Factories... For the Environment. For Product Quality.

Our elevators and escalators are currently operating in approximately 90 countries around the globe. Built placing priority on safety, our elevators, escalators and building system products are renowned for their excellent efficiency, energy savings and comfort. The technologies and skills cultivated at the Inazawa Building Systems Works in Japan and 12 global manufacturing factories are utilized in a worldwide network that provides sales, installation and maintenance in support of maintaining and improving product quality. As a means of contributing to the realization of a sustainable society, we consciously consider the environment in business operations, proactively work to realize a low-carbon, recycling-based society, and promote the preservation of biodiversity.

ISO9001/14001 certification

Our manufacturing sites have acquired ISO 9001 certification for quality management system and ISO 14001 certification for environmental management system from accredited certification bodies as below.

Mitsubishi Electric Building Solutions Corporation
Inazawa Building Systems Works



Taiwan Mitsubishi Elevator Co., Ltd.



Mitsubishi Elevator Asia Co., Ltd.



MITSUBISHI ELECTRIC BUILDING SOLUTIONS CORPORATION

HEAD OFFICE : TOKYO BLDG., 2-7-3, MARUNOUCHI, CHIYODA-KU, TOKYO 100-8310, JAPAN

www.MitsubishiElectric.com/elevator

⚠ Safety Tips: Be sure to read the instruction manual fully before using this product.