

PASSENGER ELEVATORS  
(HIGH-SPEED CUSTOM-TYPE)

NexWay





Utilizing its technological prowess and extensive experience, we have remained a leader in the vertical transportation market since entering the business in 1931. The Company's creative, innovative spirit, represented by production of the world's first spiral escalator and elevator group-control systems that use artificial-intelligence technologies, continues to receive high evaluations industry-wide. Our products and systems are renowned for their high levels of quality, reliability and safety; and it is this sense of security and trust fostered with building owners and end-users alike that has led to the global expansion of our elevator/escalator business and the after-sales network to service it.

We understand responsibilities as a good corporate citizen, and continue to implement measures for protecting the environment and ensuring a sustainable society for future generations. A number of original technologies are being introduced to ensure more efficient products, systems and manufacturing operations, thereby enhancing productivity, reducing energy consumption and providing smoother, faster and more comfortable vertical transportation systems.



# Premium Elevators Custom-designed to Match Your Needs



Our high-speed elevators are designed to keep pace with the vertical growth of cities as buildings soar to ever greater heights. Our premium elevators guarantee high levels of passenger safety and comfort, and can be customized for diverse applications including office buildings, hotels and shopping centers. We can tailor specifications to meet your exact needs and add a distinctive touch that sets your building apart from the rest.



# Principle

Based on our policy, "Quality in Motion", we provide elevators and escalators that will satisfy our customers with high levels of comfort, efficiency, ecology and safety.

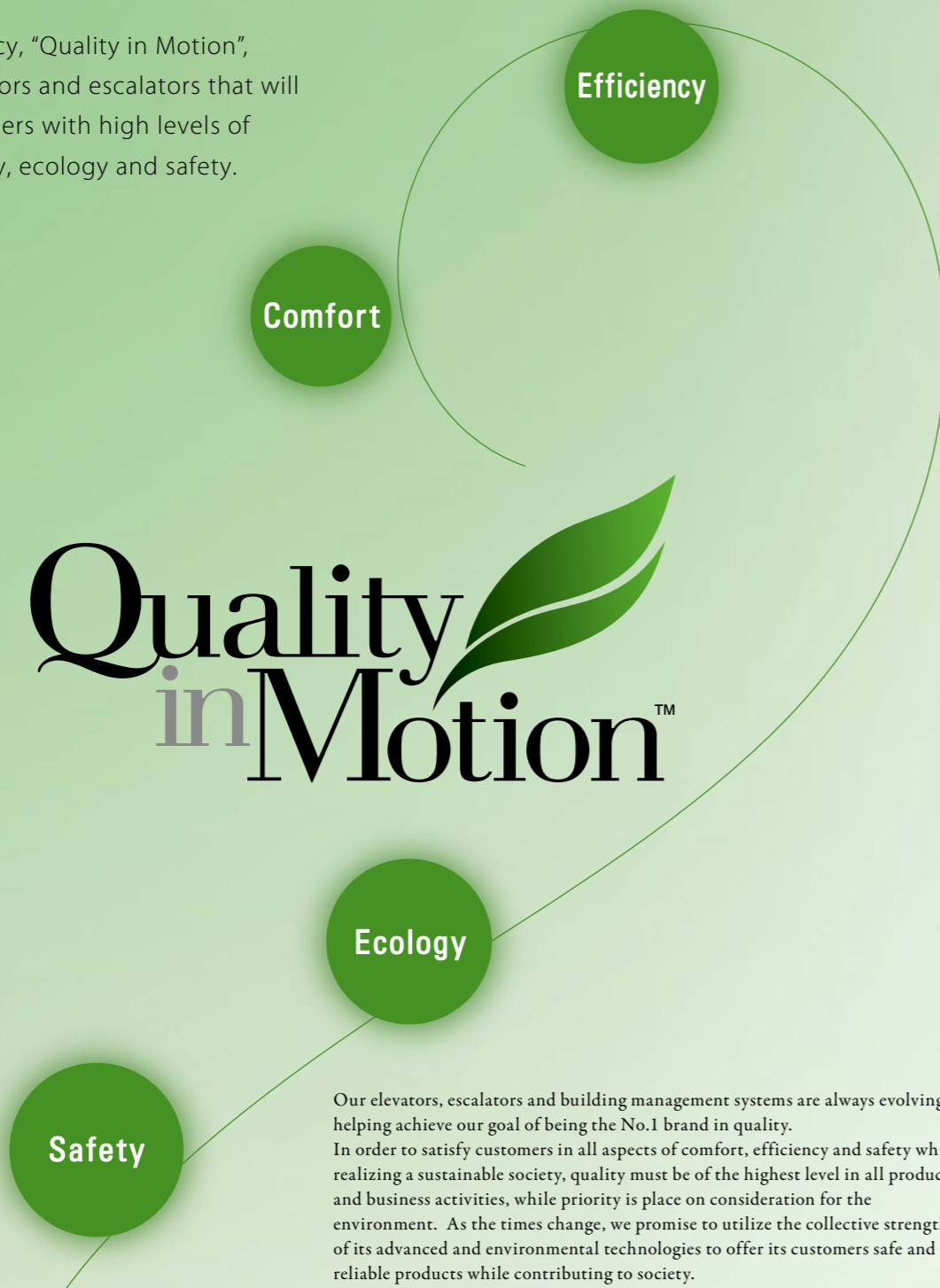

**Safety**

Our elevators, escalators and building management systems are always evolving, helping achieve our goal of being the No.1 brand in quality. In order to satisfy customers in all aspects of comfort, efficiency and safety while realizing a sustainable society, quality must be of the highest level in all products and business activities, while priority is place on consideration for the environment. As the times change, we promise to utilize the collective strengths of its advanced and environmental technologies to offer its customers safe and reliable products while contributing to society.

## We strive to be green in all of our business activities.

We take every action to reduce environmental burden during each process of our elevators' and escalators' lifecycle.



\* Quality in Motion is a trademark of Mitsubishi Electric Corporation.

# Contents

Speed/Comfort	7 - 8
Ecology/Safety	9 - 10
Efficiency	11 - 12
Displays/IT Solutions	13 - 14
Ceiling Designs/Car Operating Panels Hall Signal Fixtures/Button Line-up/Interior/Hall Designs	15 - 30
Materials and Colors	31 - 32
Features	33 - 36
Specifications/ Important Information on Elevator Planning	37 - 38

## Application

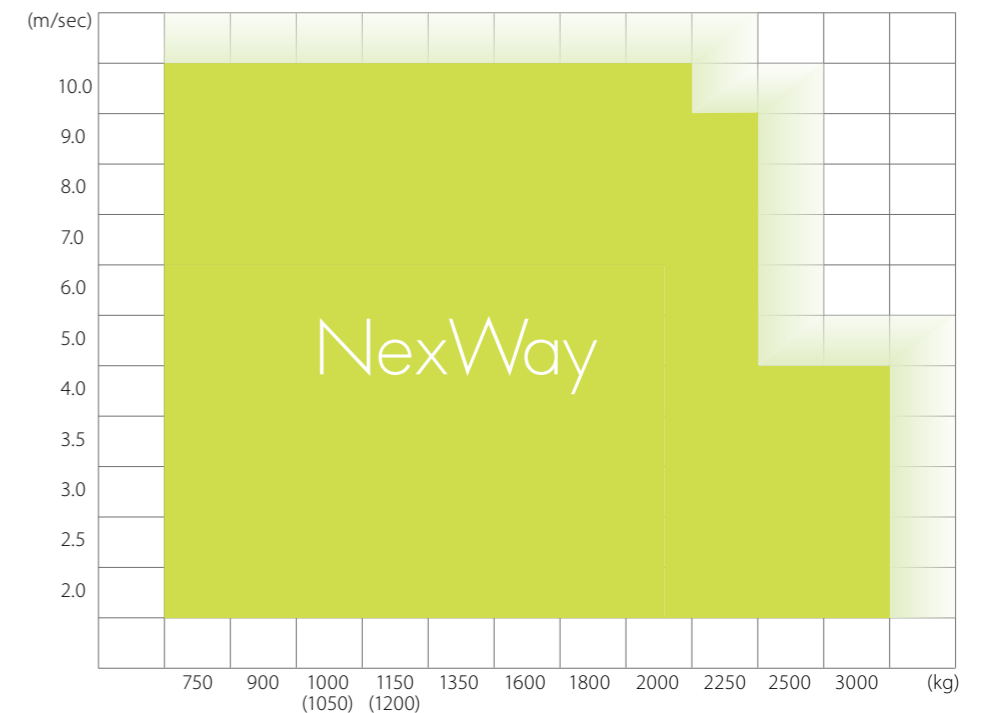



# Speed

## Traction Machine with PM Motor

(PM motor: permanent magnet motor)

The joint-lapped core built into the PM motor of the traction machine features flexible joints. The iron core acts like a hinge, which allows coils to be wound around the core more densely, resulting in improved motor efficiency and compactness. A high-density magnetic field is produced, enabling lower use of energy and resources and reduced CO<sub>2</sub> emissions.

## Super High-rise Rope Mechanics

Our new sfleX-rope® is comprised of bundles of high-intensity steel wire strands, each covered with plastic, offering higher intensity than conventional rope for safe operation despite the greater weight of longer ropes. Each wire has a higher density and wider cross-sectional area than conventional rope, which helps to reduce rope stretching caused when passengers step into the elevator.

The sfleX-rope® is a registered trademark of Mitsubishi Electric Corporation.

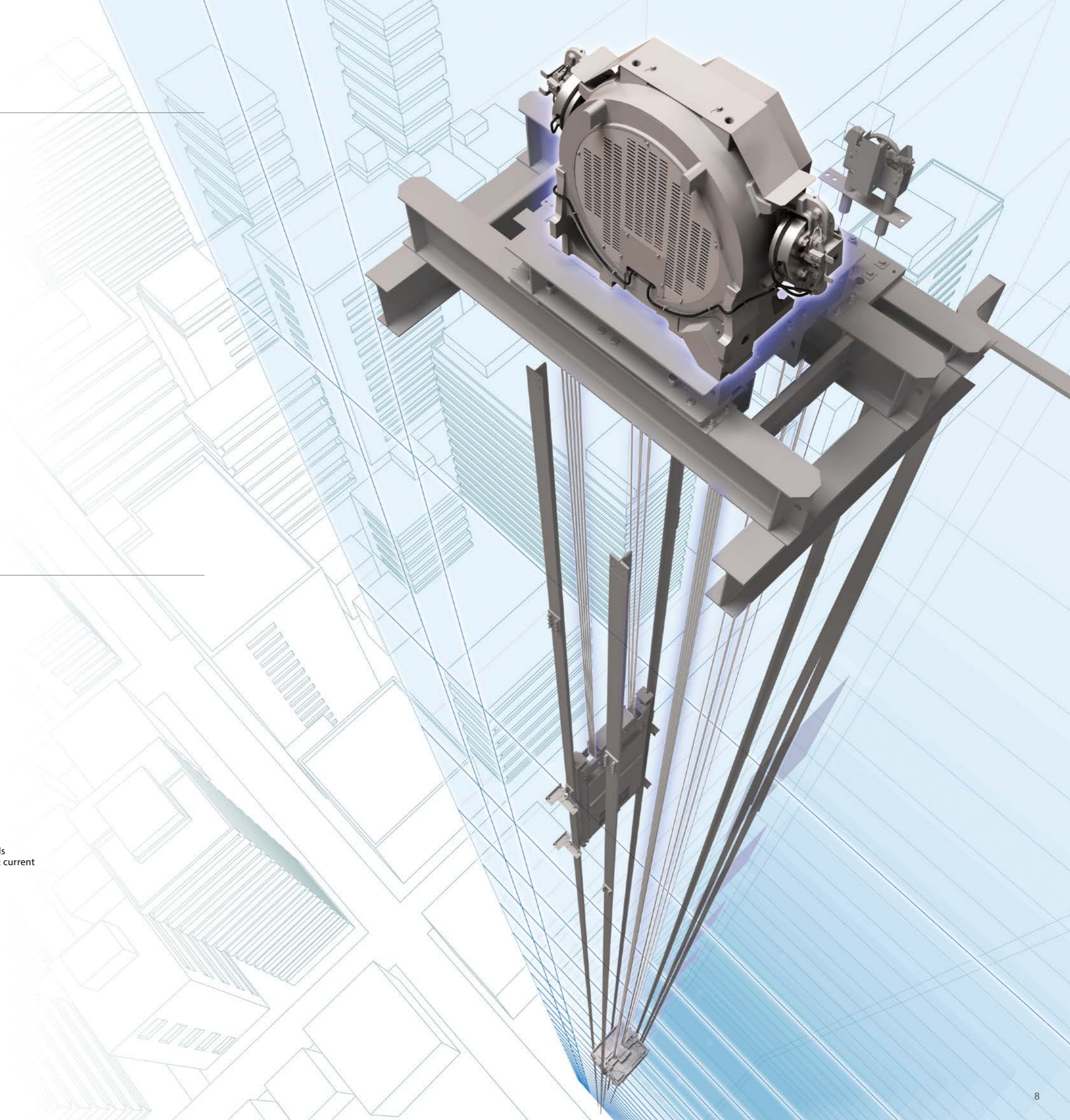

# Comfort

## Active Roller Guide (Optional\*)

The amount of lateral vibration generated by high-speed elevator cars can be tremendous. As a world's first innovation in the industry, our Active Roller Guide technology reduces this vibration by approximately 50%.

It works via an accelerometer that detects car vibration during operation, along with actuators that cancel the vibration through a controlled electromagnetic force. Our Active Roller Guides ensure a more comfortable ride than elevators employing conventional roller guides.

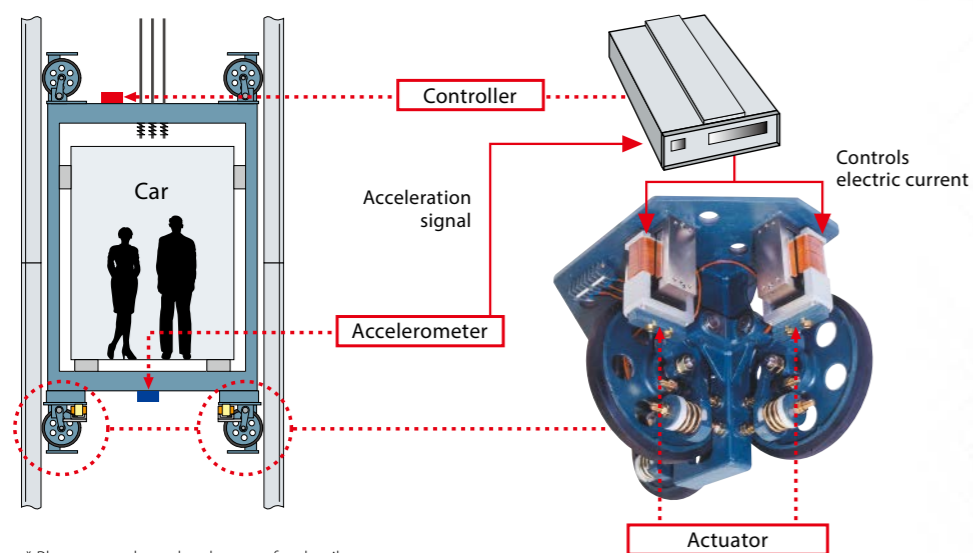

\*Please consult our local agents for details.



# Ecology

## Using Energy Wisely

Our long-term commitment to developing energy-efficient elevators has created systems and functions that make intelligent use of power.

### Milestones of Energy-saving Technologies in Elevator Development

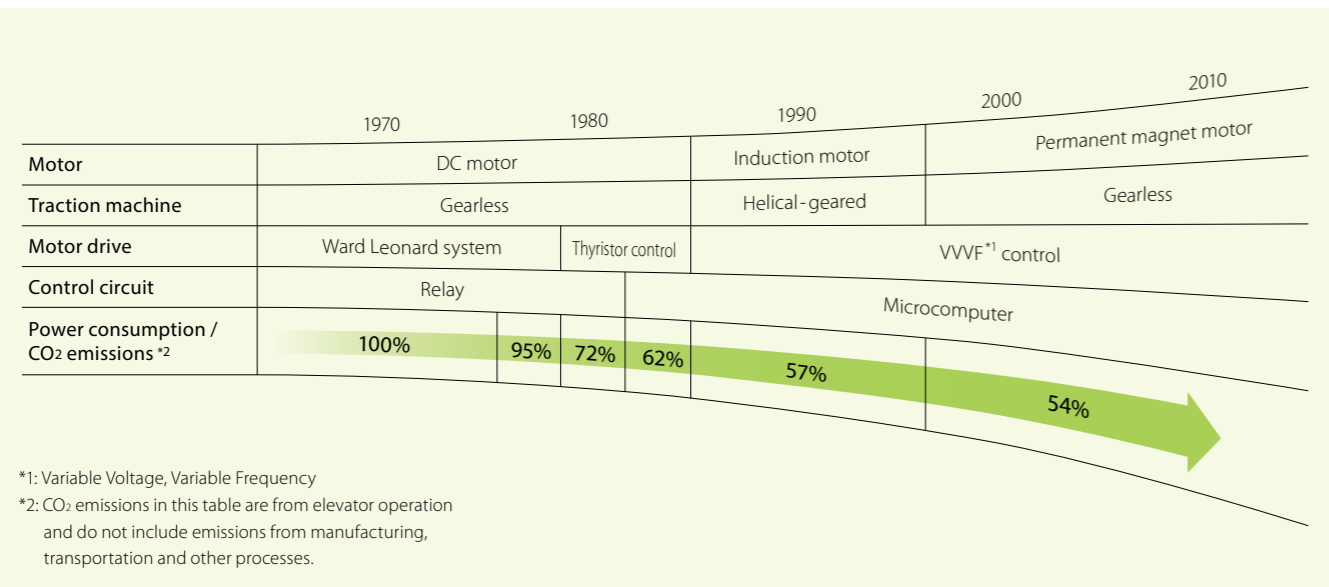

## Devices that Use Less Energy

### LED Lighting (Optional)

Used for ceiling lights and hall lanterns, LEDs boost the overall energy performance of the building. Furthermore, a long service life eliminates the need for frequent lamp replacement.



Ceiling: L210S LED downlights (yellow-orange)

#### Advantages of LEDs

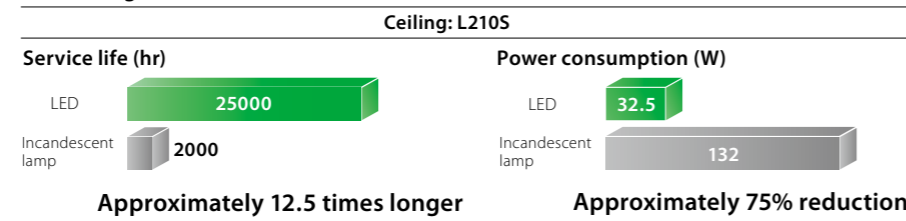

## Maximizing Operational Efficiency and Minimizing Energy Consumption

### Energy-saving Operation — Allocation Control: ESO-W (ΣAI-2200C only)

This system selects the elevator in a group that best balances operational efficiency and energy consumption. Priority is given to operational efficiency during peak hours and energy efficiency during non-peak hours.

Through a maximum 10% reduction in energy consumption compared to our conventional system, this system allows building owners to cut energy costs without sacrificing passenger convenience.

# Safety

## Emergency Situations

### Emergency Operations

Enhance safety by adding emergency operation features which quickly respond to a power failure, fire or earthquake. (Please refer to page 33 for details.)

Power failure	<b>Mitsubishi Emergency Landing Device: MELD (Optional)</b> Upon power failure, the car automatically moves to the nearest floor using a rechargeable battery to facilitate the safe evacuation of passengers.
	<b>Operation by Emergency Power Source — Automatic/Manual: OEPS (Optional)</b> Upon power failure, predetermined cars use the building's emergency power supply to move to a specified floor and open the doors for passengers to evacuate. After all cars have arrived, the predetermined cars will resume normal operation.
Fire	<b>Fire Emergency Return: FER (Optional)</b> When a key switch or the building's fire sensor is activated, all cars immediately return to a specified floor and open the doors to facilitate the safe evacuation of passengers.
	<b>Firefighters' Emergency Operation: FE (Optional)</b> When the fire operation switch is activated, the car immediately returns to a predetermined floor. The car then responds only to car calls, which facilitates firefighting and rescue operations.
Earthquake	<b>Earthquake Emergency Return: EER-P/EER-S (Optional)</b> When a primary and/or secondary wave seismic sensor is activated, all cars stop at the nearest floor and park there with the doors open to facilitate the safe evacuation of passengers.

## For Safe Boarding

### Door Safety Devices

Our reliable safety devices ensure that the doors are clear to open and close. Depending on the type of sensor, the detection area differs.



Hall Motion Sensor: HMS (Optional)



Multi-beam Door Sensor (Optional)

# Efficiency



## Destination Oriented Allocation System: DOAS (Optional for ΣAI-2200C)

### Allocating Passengers to Cars Depending on Destination Floors

When a passenger enters a destination floor at a hall, the hall operating panel immediately indicates which car will serve the floor. Because the destination floor is already registered, the passenger does not need to press a button in the car. Furthermore, dispersing passengers by destination prevents congestion in cars and minimizes waiting and traveling time. (Car destination floor indicator can be installed on the car operating panel as an option to display which floors the car stops at.)

### Example of hall arrangement

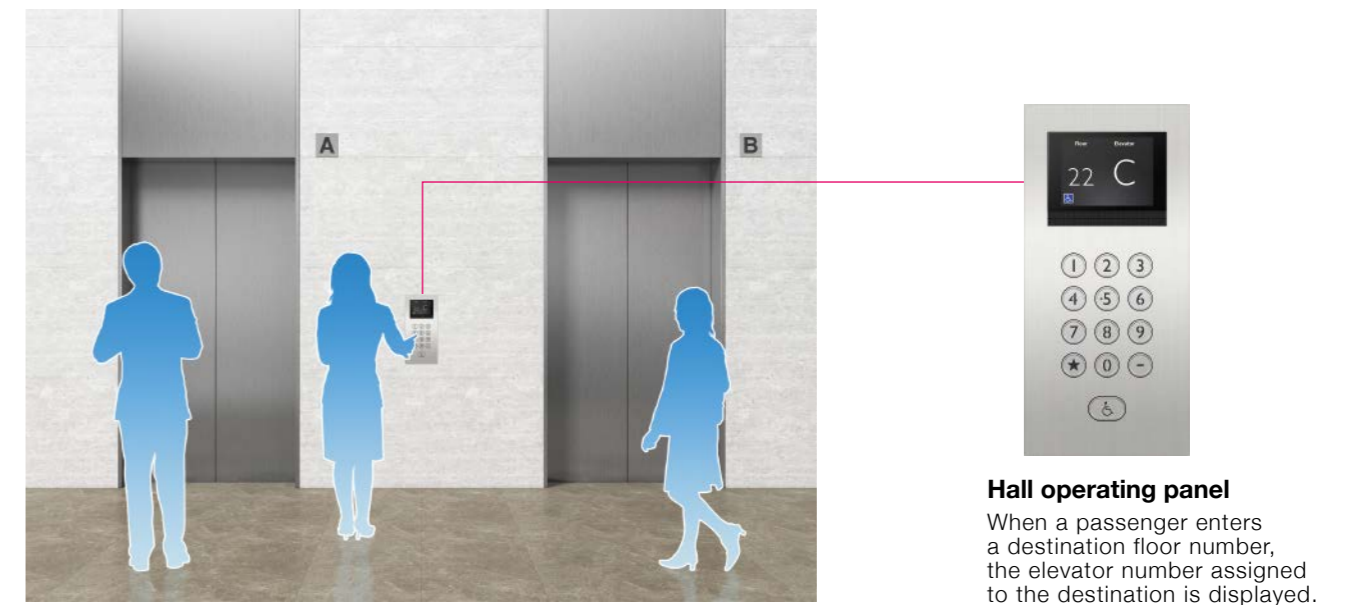

**Hall operating panel**  
When a passenger enters a destination floor number, the elevator number assigned to the destination is displayed.

(The elevator number plates are to be supplied by customer, and hall lanterns are available as options.)

## Group Control Systems: ΣAI-22 and ΣAI-2200C

ΣAI-22 and ΣAI-2200C control multiple elevators optimally according to the building size.

Group control systems	Suitable building size	Number of cars in a group
ΣAI-22 system	Small to medium	3 to 4
ΣAI-2200C system	Large (especially buildings with dynamic traffic conditions)	3 to 8

### Performance

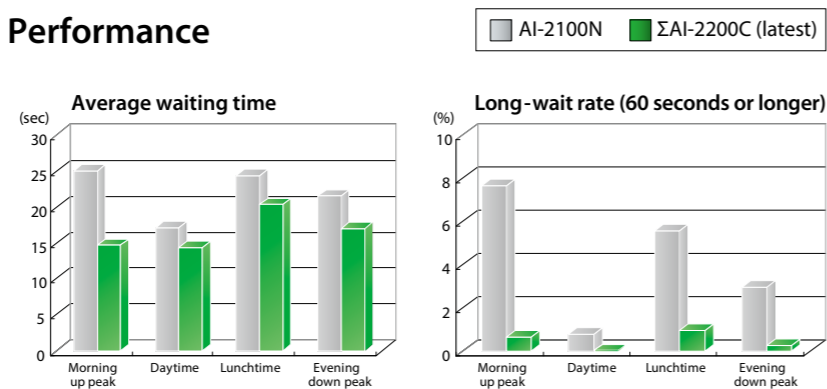

Improved: Max. 40%

Improved: Max. 80%

## Cooperative Optimization Assignment (ΣAI-2200C)

### Forecasts a near-future hall call to reduce long waits

When a hall call is registered, the algorithm predicts near-future calls that could require long waits. Through evaluation of the registered hall call and the forecasted call, the best car is assigned. All cars work cooperatively for optimum operation.

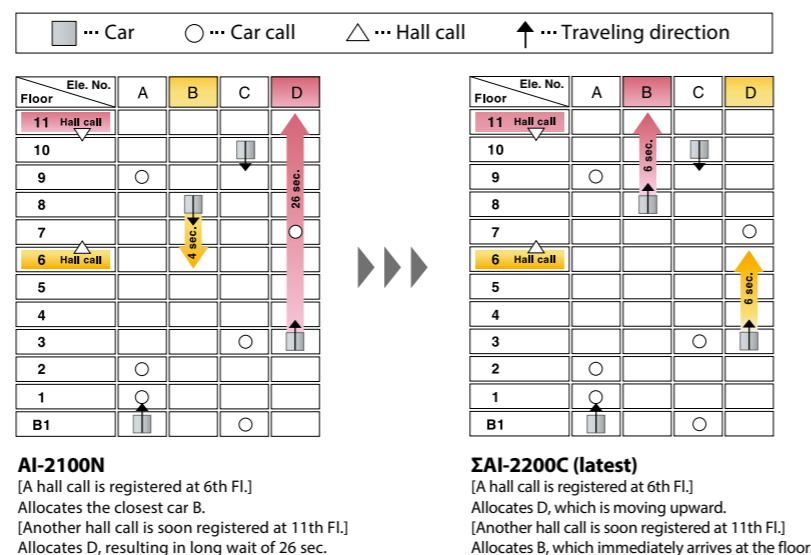

## Advantages of DOAS at Hall

### Without DOAS

Passengers wait for cars wondering which car will arrive first. Once a car arrives, regardless of the destination, passengers rush to get into the car.

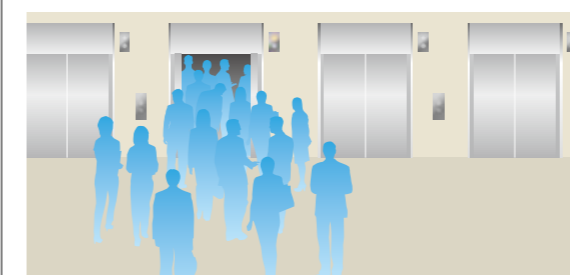

### With DOAS

When passengers enter a destination floor at a hall, the hall operating panel indicates which elevator to take. As passengers proceed to the assigned elevator, the car is on its way and there is no hurry when the car arrives.

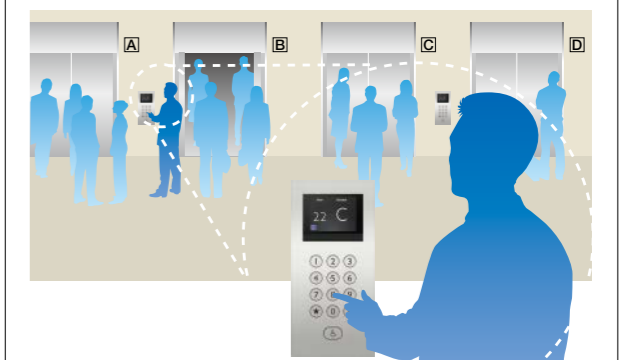



# Displays



## LCD Information Display\* (10.4- or 15-inch)

The cutting-edge LCD display delivers elevator information with stereoscopic direction arrows and animated pictures, and entertains the passengers with DVD playback/television. The display installed in a car can also run a slideshow of still images.



Example display of partial-screen animated picture



Car



Hall

## Colors

Select the best color from our five popular and eye-catching background colors.



Urban Black

Stylish Blue

Fine Green

Modern White

Elegance Brown

## Language

Standard elevator information, and date and time are available in English (US, UK or Singapore), Chinese, French, Japanese, Portuguese or Spanish.



English (US,UK or Singapore)

Chinese	电梯关门 请远离电梯门
French	Fermeture des portes Éloignez vous des portes
Japanese	ドアが閉まります ドアから離れてください
Portuguese	Porta fechando Mantenha distância da porta
Spanish	Cerrando, manténgase alejado de las puertas

Note:  
\* Please consult our local agents for the details of the LCD information display, such as the production terms and supported file formats.

Please refer to the Information Display brochure for details.

# IT Solutions

## Elevator Monitoring and Control System: MelEye (Optional)

**MelEye** closely observes the operational status of elevators that handle continually changing passenger traffic. This allows building managers to rapidly respond to changing traffic patterns, thus optimizing the performance of elevators and maximizing the added value of the whole building. The application of the latest network technology has also greatly increased the number of controllable elevators, which minimizes the cost spent on facilities such as supervisory rooms and monitors.

**MelEye** is our solution to futuristic building traffic monitoring systems.

### Monitoring screens

MelEye's user-friendly screen shows the detailed operational status of the elevators in real time.

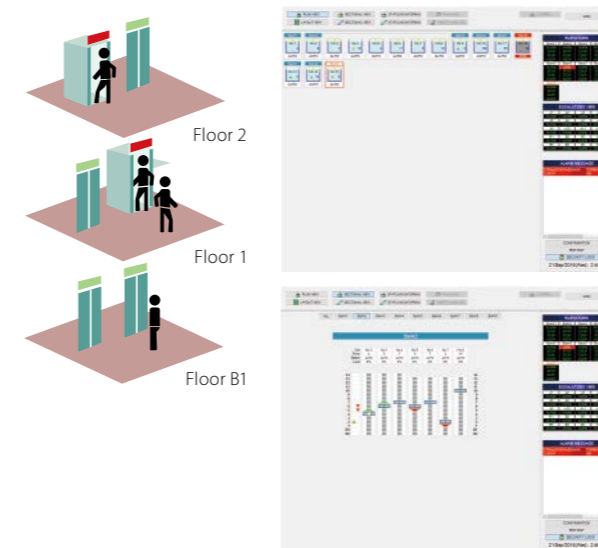

### Statistical information

The past fault logs of the elevators and escalators are recorded in addition to the operation logs of the computer.

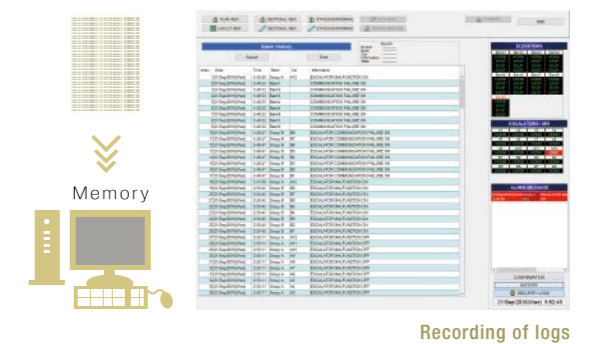

### Remote control

A computer allows remote control of special and emergency operations.

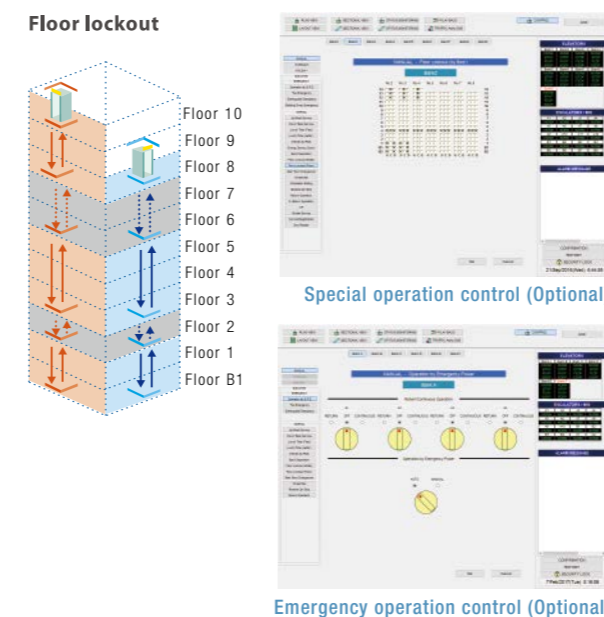

### Scheduling of special operations

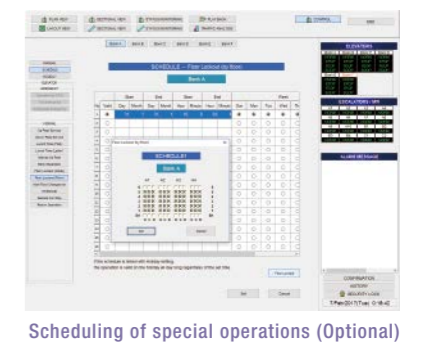



# Ceiling Designs

## Customized-1

Distinctive design using vaulted lighting and marble floor finish

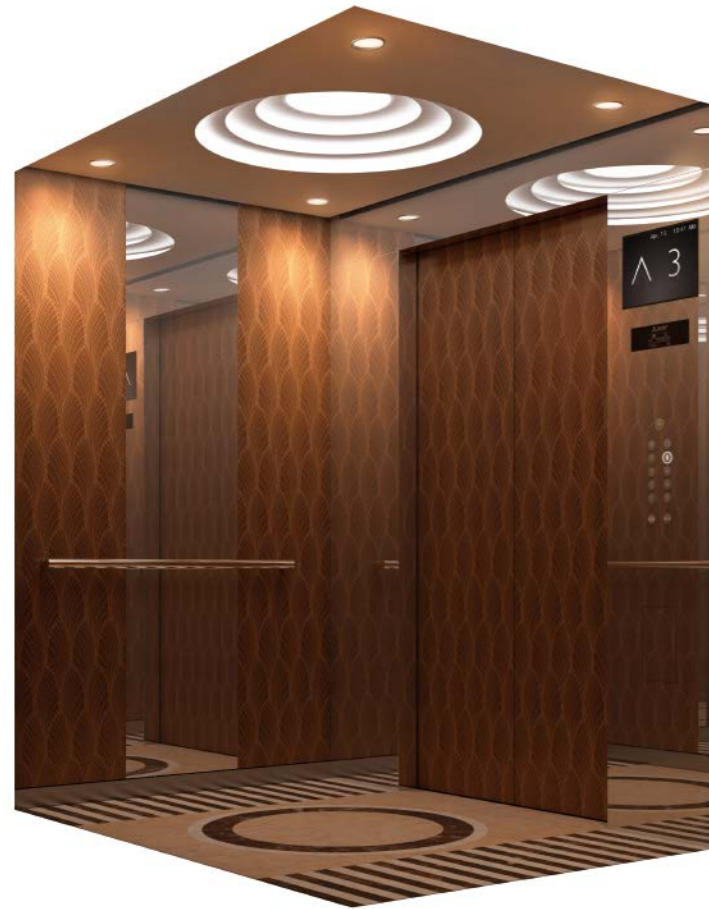

### Car Design Example

- Ceiling (Customized-1) — Panel: Painted steel sheet [Y033: White]  
Lighting: Central indirect lighting and downlights
- Walls — Colored (bronze) SUS-HE
- Transom panel — SUS-M
- Doors — Colored (bronze) SUS-HE
- Front return panels — SUS-M
- Kickplate — SUS-HL
- Flooring — Marble (supplied by customer)
- Car operating panel — CBV3-D750 (faceplate: SUS-M)
- Handrails — YH-59M
- Mirrors — YZ-55SN



## Customized-2

Indirect center lighting and downlights create a relaxing atmosphere



### Car Design Example

- Ceiling (Customized-2) — Panel: Painted steel sheet [Y033: White]  
Lighting: Central indirect lighting and downlights
- Walls — Painted steel sheet
- Transom panel — Painted steel sheet
- Doors — Painted steel sheet
- Front return panels — SUS-HL
- Kickplate — SUS-HL
- Flooring — Marble (supplied by customer)
- Car operating panel — CBN4-C710
- Handrails — YH-59M
- Mirror — YZ-52A

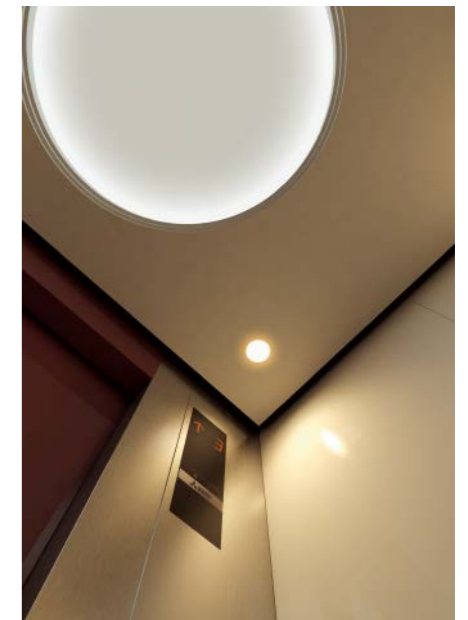



# Ceiling Designs

## L210

Sophisticated atmosphere created by downlights and shadows

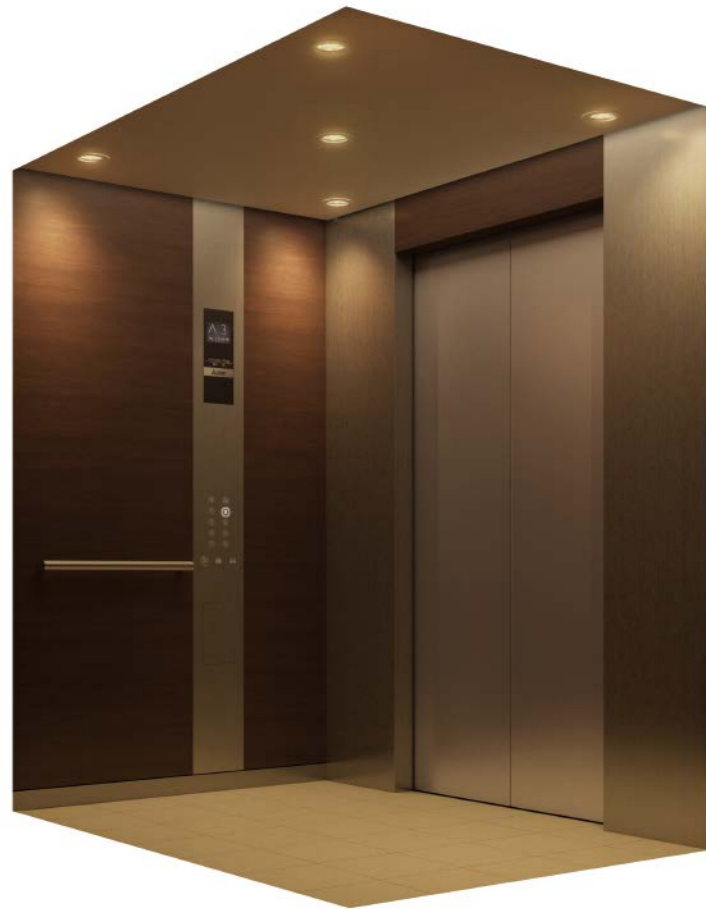

### Car Design Example

- Ceiling (L210) ———— Panel: Painted steel sheet [Y033: White]  
Lighting: Downlights (LEDs)
- Walls ———— Pattern-printed steel sheet [CP111: Dark grain]
- Transom panel ———— Pattern-printed steel sheet [CP111: Dark grain]
- Doors ———— Pattern-printed steel sheet [CP101: Silver]
- Front return panels ———— SUS-HL
- Kickplate ———— SUS-HL
- Flooring ———— Durable vinyl tiles
- Car operating panel ———— CBV3-N730
- Handrails ———— YH-59S



Optional Ceiling Design **L210S**  
Panel: SUS-HL  
Others: Same as L210.

## N300

Terraced design with illusion of increased ceiling height

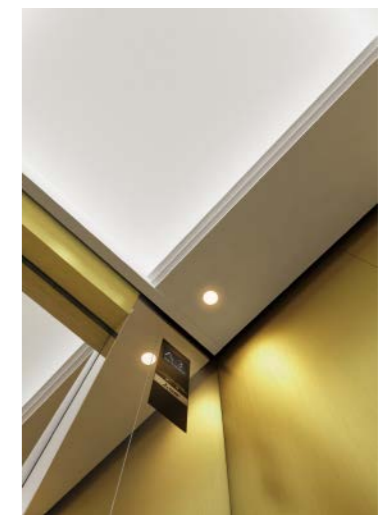

### Car Design Example

- Ceiling (N300) ———— Panel: Painted steel sheet [Y033: White]  
Lighting: Central indirect lighting and downlights
- Walls ———— Colored (gold) SUS-HL
- Transom panel ———— Colored (gold) SUS-HL
- Doors ———— SUS-M
- Front return panels ———— SUS-M
- Kickplate ———— Colored (gold) SUS-HL
- Flooring ———— Rubber tile  
(supplied by customer)
- Car operating panel ———— CBV1-C730 (faceplate: SUS-M)
- Handrails ———— YH-59M



Optional Ceiling Design **N300S**  
Panel: SUS-HL  
Others: Same as N300.



# Ceiling Designs

## N130

Light transmitted through exotic ceiling patterns



### Car Design Example

- Ceiling (N130) — Panel: Milky white resin panels  
Lighting: Full lighting
- Walls — Colored (bronze) SUS-HE (EPA-2)
- Transom panel — Colored (bronze) SUS-HE (EPA-2)
- Doors — Colored (bronze) SUS-HE (EPA-2)
- Front return panels — SUS-HL
- Kickplate — Colored (bronze) SUS-HL
- Flooring — Rubber tile (supplied by customer)
- Car operating panel — CBV1-N710 (faceplate: SUS-M)
- Handrails — YH-59M
- Mirror — YZ-53A

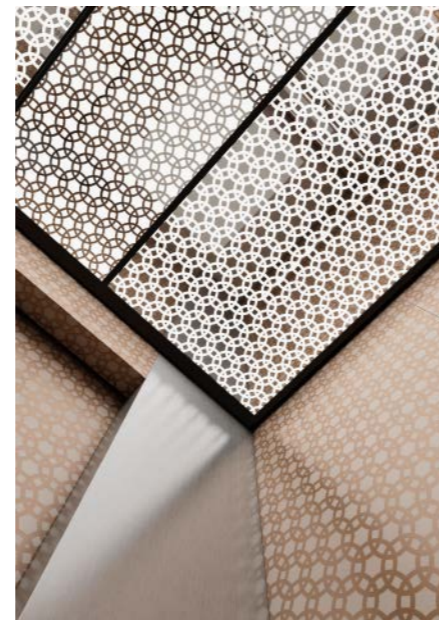

## N120

Gorgeous ceiling with lustrous translucent panels fused using refined geometric patterns



### Car Design Example

- Ceiling (N120) — Panels: [Center] Milky white resin panel  
[Sides] Resin panels with mirrored surface  
Lighting: Central lighting and downlights
- Walls — SUS-HE (EPA-3)
- Transom panel — SUS-HE (EPA-3)
- Doors — SUS-HE (EPA-3)
- Front return panels — SUS-M
- Kickplate — SUS-HL
- Flooring — Rubber tile (supplied by customer)
- Car operating panel — CBV5-N710
- Handrails — YH-59M

### Car Finish Application Table Please refer to pages 31 and 32 for materials and colors.

Materials/Finishes	Walls	Transom panel	Doors	Front return panels	Kickplate	Flooring	Sill
Stainless-steel, hairline-finish (SUS-HL)	Standard	Standard	Standard	Standard	Optional		
Pattern-printed steel sheet	Optional	Optional	Optional				
Painted steel sheet	Optional	Optional	Optional	Optional	Optional*3		
Stainless-steel, hairline-finish with etched pattern*1 (SUS-HE)	Optional	Optional	Optional				
Colored stainless-steel, hairline-finish (colored SUS-HL)	Optional	Optional	Optional		Optional		
Colored stainless-steel, hairline-finish with etched pattern*2 (colored SUS-HE)	Optional	Optional	Optional				
Stainless-steel, mirror-finish (SUS-M)	Optional	Optional	Optional	Optional			
Aluminum					Standard		
Glass windows [1300(H)×200(W)/1300(H)×300(W)]			Optional				
See-through doors			Optional				
Durable vinyl tiles (2mm thick)						Standard	
Aluminum checkered plate (3mm thick)						Optional	
Rubber tile/carpet/marble/granite (supplied by customer)						Optional	
Extruded hard aluminum							Standard
Stainless-steel							Optional

Note:  
\*1: Etching pattern EPA-1~6 only.  
\*2: Etching pattern EPA-1~3 only.  
\*3: Only available in dark gray.







# Car Operating Panels

For side wall

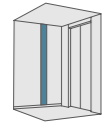

Segment LED indicator \*1

Segment LED indicator \*1

Segment LED indicator \*1

LCD indicator (5.7-inch) only



CBV-N710 \*2, 3  
(CBV-N716) \*2, 3, 4



Dot LED indicator  
CBV-N720 \*2, 3  
(CBV-N726) \*2, 3, 4



LCD indicator  
CBV-N730 \*2, 3  
(CBV-N736) \*2, 3, 4



CBV-N712 \*2, 3  
(with alarm indication  
and tactile buttons for EN81-70)  
(CBV-N717) \*2, 3, 4, 5



Dot LED indicator  
CBV-N722 \*2, 3  
(CBV-N727) \*2, 3, 4, 5



LCD indicator  
CBV-N732 \*2, 3  
(CBV-N737) \*2, 3, 4, 5



CBU-N710 \*2



Dot LED indicator  
CBU-N720 \*2, 3  
(CBU-N726) \*2, 3, 4

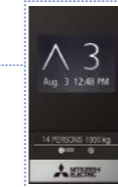

LCD indicator  
CBU-N730 \*2, 3  
(CBU-N736) \*2, 3, 4



CBVF-N228  
Keypad type

Car destination floor indicator



CBVF-N229S  
(with alarm indication  
and buttons for EN81-70)  
Keypad type



CBVF-N229L  
(with alarm indication  
and buttons for EN81-70)  
Keypad type



Numbers: Flat buttons  
Star: Tactile button  
(stainless-steel matte)

Notes:

- \*1: Segment LED indicators cannot display some letters of alphabet. Please consult our local agents for details.
- \*2: Please select a button type referring to page 27, and enter the number in the space shown as ■.
- \*3: Faceplates with stainless-steel, mirror-finish are also available (optional). Please consult our local agents for details.
- \*4: The type in parentheses ( ) shows an auxiliary car operating panel (optional). The design is slightly different from the above images. Please consult our local agents for further information such as installation location.
- \*5: Please consult our local agents for the production terms, etc.



# Hall Signal Fixtures

## Hall position indicators and buttons

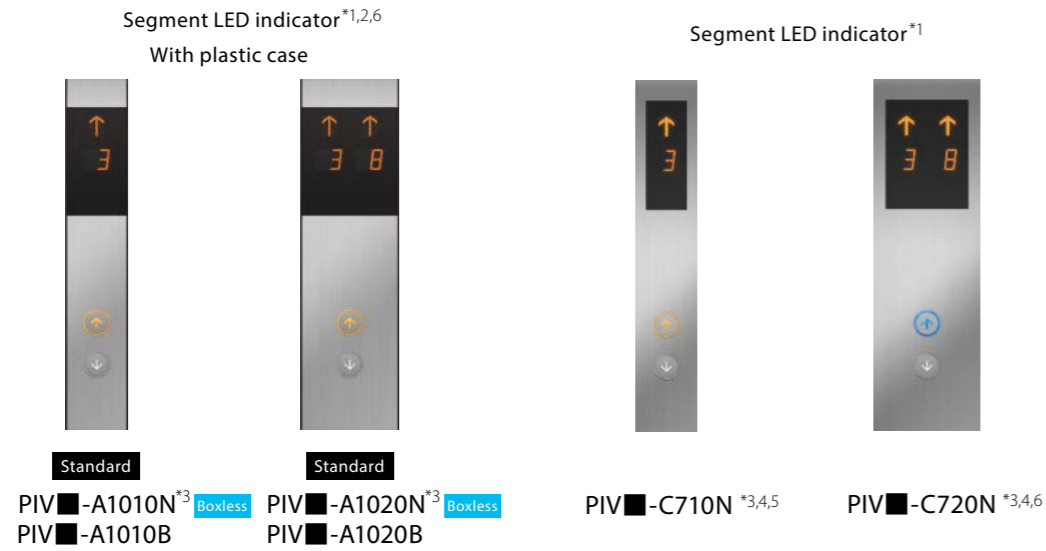

## Hall buttons

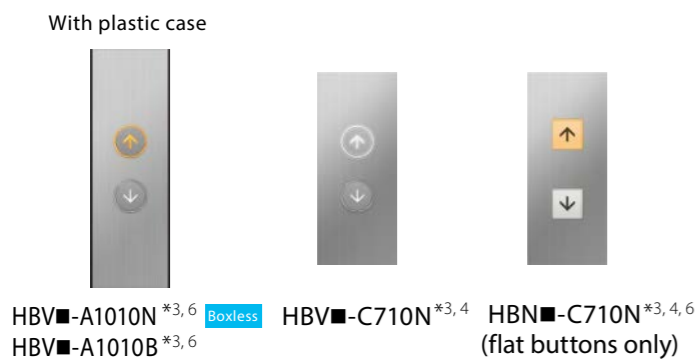

## No-entry indicators for EN81-73



Notes:  
\*1: Segment LED indicators cannot display some letters of alphabet. Please consult our local agents for details.  
\*2: Dot LED indicators are available (optional). Please consult our local agents for details.  
\*3: Please select a button type referring to page 27, and enter the number in the space shown as ■.  
\*4: Faceplates with stainless-steel, mirror-finish are also available (optional). Please consult our local agents for details.  
\*5: These types are applicable to EN81-70 compliant elevators only in 1C-2BC where one car is controlled independently.  
\*6: These types are not applicable to elevators complying with EN81-70.

## Hall lanterns

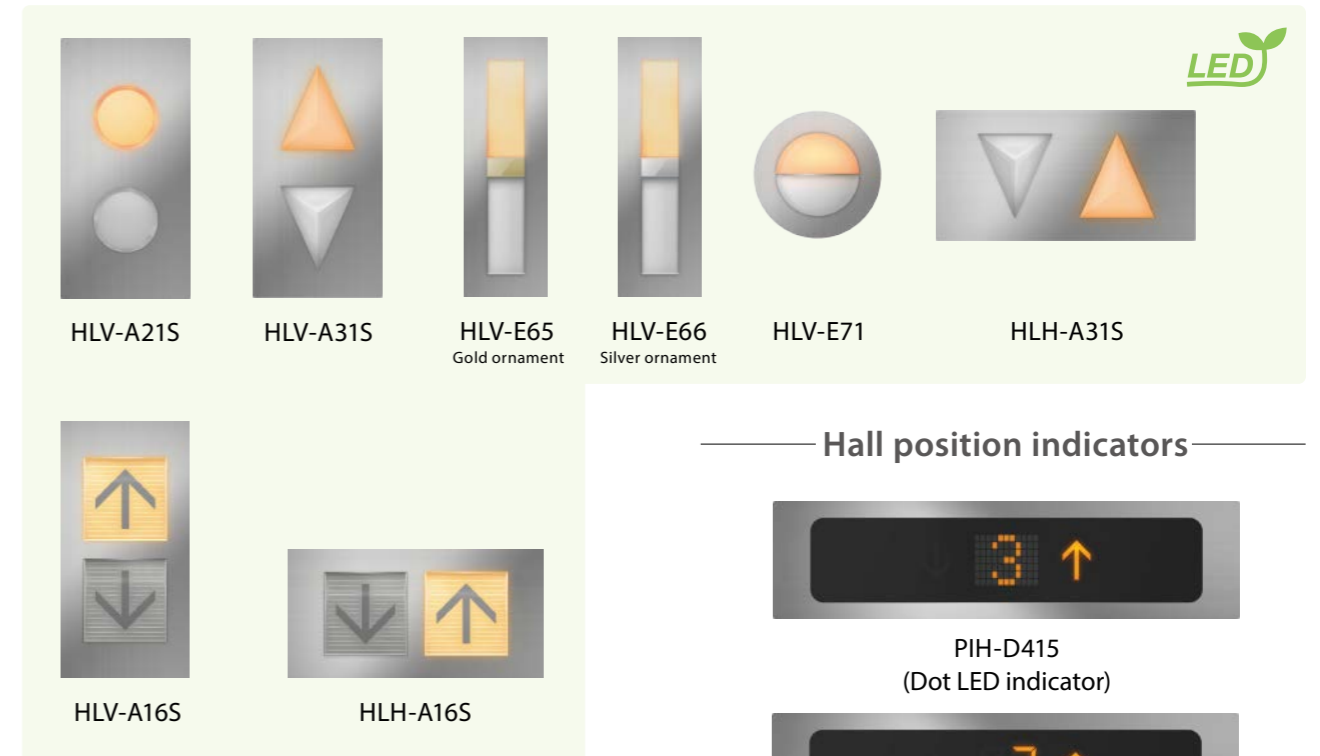

## Hall position indicators

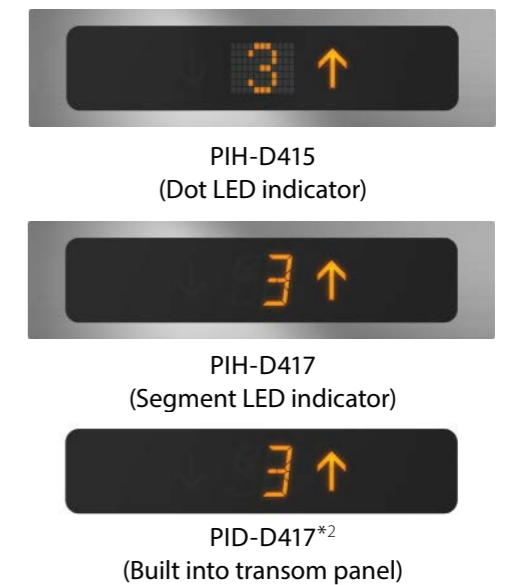

## LCD position indicator

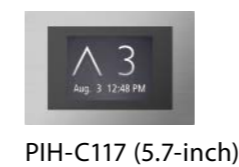

## LCD information displays



## Hall position indicator with lantern



## Cross-section of boxless fixtures

These hall signal fixtures can be easily mounted on the wall surface without having to cut into the wall to embed the back box.

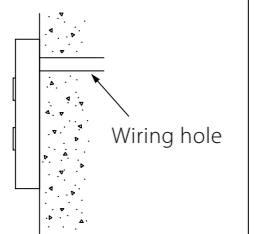



# Button Line-up

## Buttons accented with LED halo illumination

Illuminated characters and halos attract user's attention. Tactile and flat buttons (stainless-steel with non-directional hairline-finish) are available in three illumination colors: yellow-orange, white and blue.

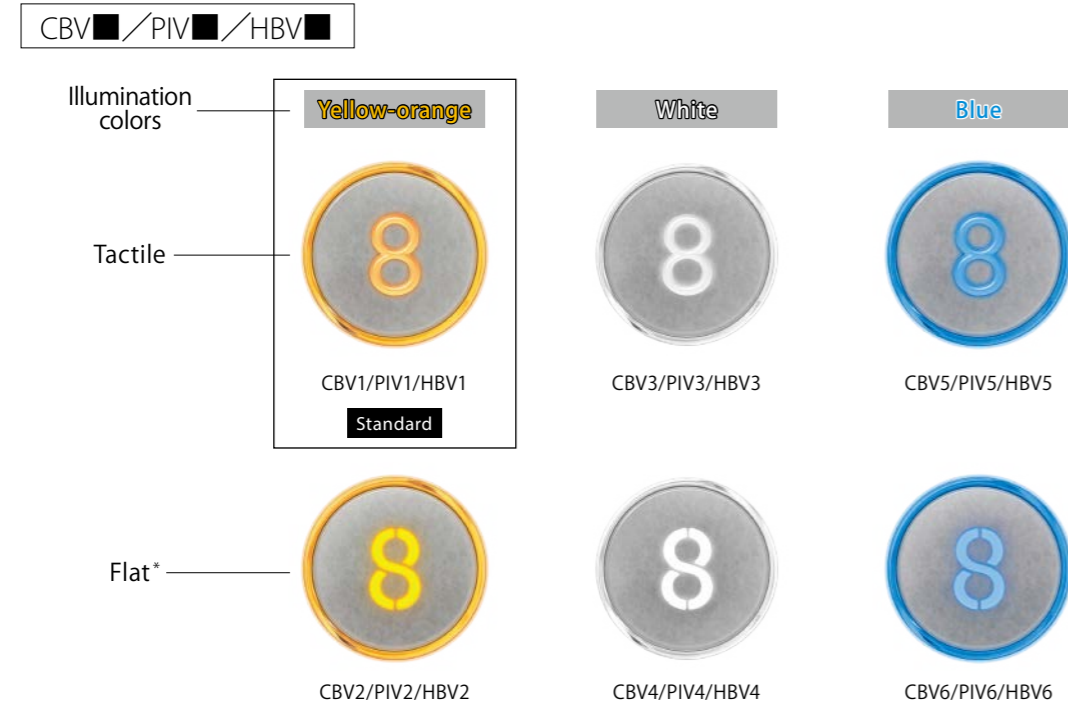

## Square buttons

The entire buttons (excluding characters) are illuminated yellow-orange, white or blue.



Note:  
\* Flat buttons are not applicable to regulation EN81-70.

# Interior

## Mirrors



## Handrails

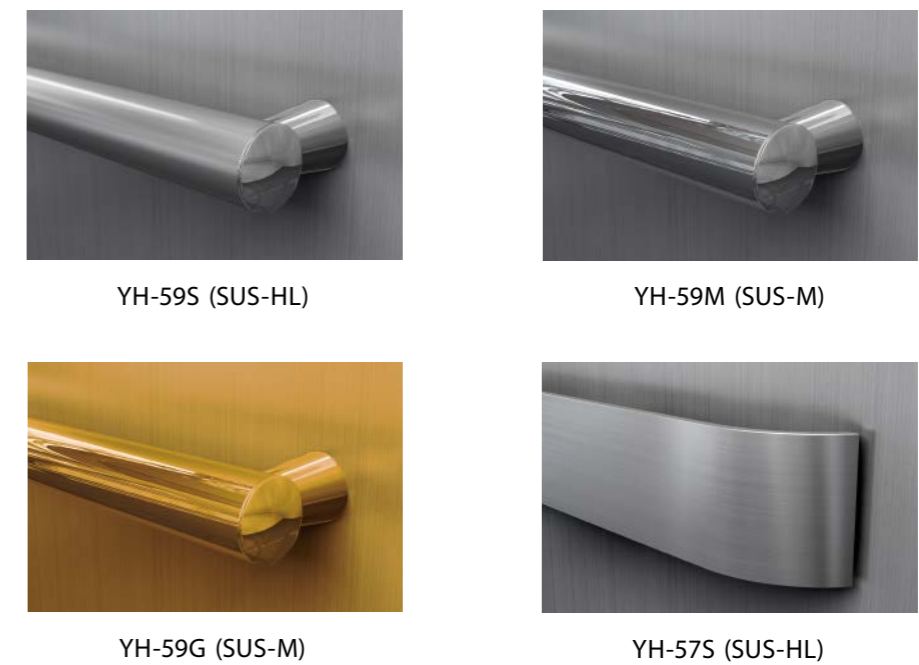

Actual colors may differ slightly from those shown. Please refer to page 20 for the explanations of SUS-HL and SUS-M.

# Hall Designs

E-312 Splayed Jamb with Transom Panel  
E-212 Square Jamb with Transom Panel



### Hall Design Example of E-312

Jamb ———— SUS-HL  
Transom panel ———— Colored (black) SUS-HE  
Doors ———— Colored (black) SUS-HE  
Hall lantern ———— HLV-E71  
Hall button ———— HBV3-C710N

E-302 Splayed Jamb  
E-202 Square Jamb



### Hall Design Example of E-302

Jamb ———— SUS-HL  
Doors ———— Painted steel sheet (Y033: White)  
Hall lantern ———— HLV-E66  
Hall button ———— HBV1-C710N

E-102 Narrow Jamb **Standard**



E-312 Splayed Jamb with Transom Panel  
E-212 Square Jamb with Transom Panel



### Hall Design Example of E-312

Jamb ———— SUS-HL  
Transom panel ———— SUS-HL  
Doors ———— See-through doors  
LCD information display ———— PIH-C226  
Hall button ———— HBV5-C710N

### Hall Design Example

Jamb ———— SUS-HL  
Doors ———— SUS-HL  
Hall position indicator and button ———— PIV1-A1010N **Boxless**

## Entrance Finish Application Table Please refer to pages 31 and 32 for materials and colors.

Materials/Finishes	Jamb	Transom panel	Doors	Sill
Stainless-steel, hairline-finish (SUS-HL)	Standard	Optional	Standard	
Painted steel sheet	Optional	Optional	Optional	
Stainless-steel, hairline-finish with etched pattern (SUS-HE)		Optional	Optional	
Stainless-steel, mirror-finish (SUS-M)			Optional	
Glass windows [1300(H)×200(W)/1300(H)×300(W)]			Optional	
See-through doors			Optional	
Extruded hard aluminum				Standard
Stainless-steel				Optional



# Materials and Colors

## [Car] Walls, doors and transom panel

**Colored stainless-steel, hairline-finish**

Gold Bronze

**Etching patterns (gold or bronze)**  
\*Please refer to the etching finish pattern book, EFA1, for details.

EPA-1 EPA-2 EPA-3

**Pattern-printed steel sheet**

CP23 Minimal stripe CP101 Silver CP141 Bright slate CP121 Primary grain CP111 Dark grain

Non-etched surface Etched surface

## Ceiling

**Painted steel sheet**  
(L210, N300, customized-1, customized-2 only)

Y033 White

Y073 Light beige

Y055 Dark gray

**Stainless-steel Hairline-finish**  
(Applicable to L210S or N300S only)

## [Car] Walls, doors and transom panel [Hall] Doors, transom panel and jamb

**Stainless-steel**

Hairline-finish Mirror-finish (not applicable to the hall transom panel and jamb)

**Etching patterns (stainless-steel)**  
\*Not applicable to the jamb; please refer to the etching finish pattern book, EFA1, for details.

EPA-1 EPA-2 EPA-3 EPA-4 EPA-5 EPA-6

Non-etched surface Etched surface

**Painted finish Neutral Colors**

Y033 White Y004 Beige Y071 Neutral beige Y002 Dark brown Y055 Dark gray

**Cool Colors**

Y117 Lime green Y118 Light grayish blue Y116 Blue

**Warm Colors**

Y016 Light brown Y119 Carrot orange Y014 Red-violet

## [Hall] Doors and transom panel

**Etching patterns** \*Please refer to the etching finish pattern book, EF4, for details.

EP-A-004 EP-A-011 EP-A-021 EP-B-009 EP-D-006 EP-F-004

## Flooring

**Durable vinyl tiles**

PR803 Gray PR812 Dim-gray PR801 Cream beige PR810 Ocher

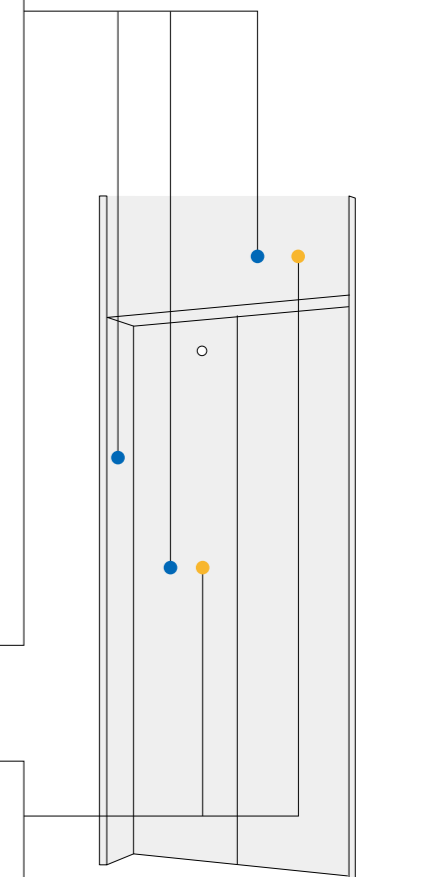

# Features (1/2)

Feature	Abbreviation	Description	1C to 2C 2BC	3C to 4C ΣAI-22	3C to 8C ΣAI-2200C
<b>EMERGENCY OPERATIONS AND FEATURES</b>					
Building Management System — GateWay	BMS-GW	Each elevator's status and operation can be monitored and controlled using a building management system which manages various facilities in the building via the interface for the elevator system.	⊙	⊙	⊙
Earthquake Emergency Return	EER-P EER-S	Upon activation of primary and/or secondary wave seismic sensors, all cars stop at the nearest floor, and park there with the doors open to facilitate the safe evacuation of passengers.	⊙	⊙	⊙
Emergency Car Lighting	ECL	Car lighting which turns on immediately when power fails, providing a minimum level of lighting within the car. (Choice of dry-cell battery or trickle-charge battery.)	⊙	⊙	⊙
Fire Emergency Return	FER	Upon activation of a key switch or a building's fire alarm, all calls are canceled, all cars immediately return to a specified evacuation floor and the doors open to facilitate the safe evacuation of passengers.	⊙	⊙	⊙
Firefighters' Emergency Operation	FE	During a fire, when the fire operation switch is activated, the car calls of a specified car and all hall calls are canceled and the car immediately returns to a predetermined floor. The car then responds only to car calls which facilitate fire-fighting and rescue operation.	⊙	⊙	⊙
MelEye Mitsubishi Elevators & Escalators Monitoring and Control System	WP-W	Each elevator's status and operation can be monitored and controlled using an advanced Web-based technology which provides an interface through personal computers. Special optional features such as preparation of traffic statistics and analysis are also available.	⊙	⊙	⊙
Mitsubishi Emergency Landing Device	MELD	Upon power failure, a car equipped with this function automatically moves and stops at the nearest floor using a rechargeable battery, and the doors open to facilitate the safe evacuation of passengers. (Maximum allowable floor-to-floor distance is 11 meters.)	⊙	⊙	⊙
Operation by Emergency Power Source — Automatic/Manual	OEPS	Upon power failure, predetermined car(s) uses the building's emergency power supply to move to a specified floor, where the doors then open to facilitate the safe evacuation of passengers. After all cars have arrived, the predetermined car(s) resume normal operation.	⊙	⊙	⊙
Supervisory Panel	WP	Each elevator's status and operation can be remotely monitored and controlled through a panel installed in a building's supervisory room, etc.	⊙	⊙	⊙#1

## DOOR OPERATION FEATURES

Automatic Door-open Time Adjustment	DOT	The time doors are open will automatically be adjusted depending on whether the stop was called from the hall or the car, to allow smooth boarding of passengers or loading of baggage.	—	—	⊙
Automatic Door Speed Control	DSAC	Door load on each floor, which can depend on the type of hall doors, is monitored to adjust the door speed, thereby making the door speed consistent throughout all floors.	⊙	⊙	⊙
Door Load Detector	DLD	When excessive door load has been detected while opening or closing, the doors immediately reverse.	⊙	⊙	⊙
Door Nudging Feature — With Buzzer	NDG	A buzzer sounds and the doors slowly close when they have remained open for longer than the preset period. With the AAN-B or AAN-G feature, a beep and voice guidance sound instead of the buzzer.	⊙	⊙	⊙
Door Sensor Self-diagnosis	DODA	Failure of non-contact door sensors is checked automatically, and if a problem is diagnosed, the door-close timing is delayed and the closing speed is reduced to maintain elevator service and ensure passenger safety.	⊙	⊙	⊙
Electronic Doorman	EDM	Door open time is minimized using the SR or Multi-beam Door Sensor feature that detects passengers boarding or exiting.	⊙	⊙	⊙
Extended Door-open Button	DKO-TB	When the button inside a car is pressed, the doors will remain open longer to allow loading and unloading of baggage, a stretcher, etc.	⊙	⊙	—
Hall Motion Sensor	HMS	Infrared-light is used to scan a 3D area near the open doors to detect passengers or objects.	⊙	⊙	⊙
Multi-beam Door Sensor	—	Multiple infrared-light beams cover some height of the doors to detect passengers or objects as the doors close. (Cannot be combined with the SR feature.)	⊙	⊙	⊙#2
Reopen with Hall Button	ROHB	Closing doors can be reopened by pressing the hall button corresponding to the traveling direction of the car.	⊙	⊙	⊙
Repeated Door-close	RDC	Should an obstacle prevent the doors from closing, the doors will repeatedly open and close until the obstacle is cleared from the doorway.	⊙	⊙	⊙
Safety Door Edge	SDE	The sensitive door edge detects passengers or objects during door closing.	⊙	⊙	⊙
Safety Ray	SR	One or two infrared-light beams cover the full width of the doors as they close to detect passengers or objects. (Cannot be combined with the Multi-beam Door Sensor feature.)	⊙	⊙	⊙#2

## OPERATIONAL AND SERVICE FEATURES

Attendant Service	AS	Exclusive operation where an elevator can be operated using the buttons and switches located in the car operating panel, allowing smooth boarding of passengers or loading of baggage.	⊙	⊙	⊙
Automatic Bypass	ABP	A fully-loaded car bypasses hall calls in order to maintain maximum operational efficiency.	⊙#3	⊙	⊙
Automatic Hall Call Registration	FSAT	If one car cannot carry all waiting passengers because it is full, another car will automatically be assigned for the remaining passengers.	⊙	⊙	⊙

Notes: 1C-2BC (1-car selective collective) - Standard, 2C-2BC (2-car group control system) - Optional  
 ΣAI-22 (3- to 4-car group control system) - Optional, ΣAI-2200C (3- to 8-car group control system) - Optional  
 ⊙=Standard ⊙=Optional †=Not applicable to 1C-2BC —= Not applicable

#1: Please consult our local agents for the production terms, etc.

#2: • When the DOAS is applied, AECC is ⊙ and the Safety Ray (SR) or Multi-beam Door Sensor feature should be installed.  
 • The DOAS cannot be combined with some features. Please refer to the ΣAI-2200C brochure for those features.

#3: Optional when the operation system is 1C-2BC.

Feature	Abbreviation	Description	1C to 2C 2BC	3C to 4C ΣAI-22	3C to 8C ΣAI-2200C
<b>OPERATIONAL AND SERVICE FEATURES (Continued from the previous page.)</b>					
Backup Operation for Group Control Microprocessor	GCBK	An operation by car controllers which automatically maintains elevator operation in the event that a microprocessor or transmission line in the group controller has failed.	⊙†	⊙	⊙
Car Call Canceling	CCC	When a car has responded to the final car call in one direction, the system regards remaining calls in the other direction as mistakes and clears them from the memory.	⊙	⊙	⊙
Car Fan Shut Off — Automatic	CFO-A	If there are no calls for a specified period, the car ventilation fan will automatically turn off to conserve energy.	⊙	⊙	⊙
Car Light Shut Off — Automatic	CLO-A	If there are no calls for a specified period, the car lighting will automatically turn off to conserve energy.	⊙	⊙	⊙
Continuity of Service	COS	A car which is experiencing trouble is automatically withdrawn from group control operation to maintain overall group performance.	⊙†	⊙	⊙
Elevator and Security System Interface	EL-SCA EL-SC	Personal authentication by building's security devices can trigger predetermined elevator operation such as permission of access to private floors, automatic registration of a hall call and a destination floor, and priority service.	⊙	⊙	⊙
False Call Canceling — Automatic	FCC-A	If the number of registered car calls does not correspond to the car load, all calls are canceled to avoid unnecessary stops.	⊙	⊙	⊙
False Call Canceling — Car Button Type	FCC-P	If a wrong car button is pressed, it can be canceled by quickly pressing the same button again twice.	⊙	⊙	⊙
High Accuracy Landing Feature	HARL	The car landing level is adjusted to a high level of precision in order to ensure a landing accuracy of ±5mm under any conditions.	⊙	⊙	⊙
Independent Service	IND	Exclusive operation where a car is withdrawn from group control operation for independent use, such as maintenance or repair, and responds only to car calls.	⊙	⊙	⊙
Motor Drive Mix	MDX	The rate of car acceleration and deceleration is automatically increased according to the car load to reduce passenger waiting and travel time.	—	⊙	⊙
Next Landing	NXL	If the elevator doors do not open fully at a destination floor, the doors close, and the car automatically moves to the next or nearest floor where the doors open.	⊙	⊙	⊙
Non-service to Specific Floors — Car Button Type	NS-CB	To enhance security, service to specific floors can be disabled using the car operating panel. This function is automatically deactivated during emergency operation.	⊙	⊙	⊙
Non-service to Specific Floors — Switch/Timer Type	NS-NS-T	To enhance security, service to specific floors can be disabled using a manual or timer switch. This function is automatically deactivated during emergency operation.	⊙	⊙	⊙
Out-of-service by Hall Key Switch	HOS HOS-T	For maintenance or energy-saving measures, a car can be taken out of service temporarily with a key switch (with or without a timer) mounted in a specified hall.	⊙	⊙	⊙
Out-of-service — Remote	RCS	With a key switch on the supervisory panel, etc., a car can be called to a specified floor after responding to all car calls, and then automatically be taken out of service.	⊙	⊙	⊙
Overload Holding Stop	OLH	A buzzer sounds to alert the passengers that the car is overloaded. The doors remain open and the car will not leave that floor until enough passengers exit the car.	⊙	⊙	⊙
Return Operation	RET	Using a key switch on the supervisory panel, a car can be withdrawn from group control operation and called to a specified floor. The car will park on that floor with the doors open, and not accept any calls until independent operations begin.	⊙	⊙	⊙
Rope Replacement Alarm	RRA	This self-diagnosis function gives an alert when rope replacement timing has approached.	⊙	⊙	⊙
Safe Landing	SFL	If a car has stopped between floors due to some equipment malfunction, the controller checks the cause, and if it is considered safe to move the car, the car will move to the nearest floor at a low speed and the doors will open.	⊙	⊙	⊙
Secret Call Service	SCS-B	To enhance security, car calls for desired floors can be registered only by entering secret codes using the car buttons on the car operating panel. This function is automatically deactivated during emergency operation.	⊙	⊙	⊙

## GROUP CONTROL FEATURES

Bank-separation Operation	BSO	Hall buttons and the cars called by each button can be divided into several groups for independent group control operation to serve special needs or different floors.	⊙†,#1	⊙	⊙
Car Allocation Tuning	CAT	The number of cars allocated or parked on crowded floors is controlled not just according to the conditions on those crowded floors but also the operational status of each car and the traffic on each floor.	—	—	⊙
Car Travel Time Evaluation	—	Cars are allocated to hall calls by considering the number of car calls that will reduce passenger waiting time in each hall and the travel time of each car.	—	⊙	⊙
Closest-car Priority Service	CNPS	A function to give priority allocation to the car closest to the floor where a hall call button has been pressed, or to reverse the closing doors of the car closest to the pressed hall call button on that floor. (Cannot be combined with hall position indicators.)	—	⊙#1	⊙
Congested-floor Service	CFS	The timing of car allocation and the number of cars to be allocated to floors where meeting rooms or ballrooms exist and the traffic intensifies for short periods of time are controlled according to the detected traffic density data for those floors.	—	⊙	⊙
Cooperative Optimization Assignment	—	The system predicts a potential hall call which could cause longer waiting time. Car assignment is performed considering not only current and new calls but also near-future calls.	—	—	⊙
Destination Oriented Allocation System	DOAS	When a passenger enters a destination floor at a hall, the hall operating panel indicates which car will serve the floor. The passenger does not need to press a button in the car. Dispersing passengers by destination prevents congestion in the cars and minimizes waiting and traveling time.	—	—	⊙#2



# Features (2/2)

Feature	Abbreviation	Description	1C to 2C 2BC	3C to 4C ΣAI-22	3C to 8C ΣAI-2200C
<b>GROUP CONTROL FEATURES (Continued from the previous page.)</b>					
Distinction of Traffic Flow with Neural Networks	NN	Traffic flows in a building are constantly monitored using neural network technology, and the optimum operational pattern for the LTS, UPS feature, etc. is selected or canceled accordingly at the appropriate time.	—	—	Ⓢ
Down Peak Service	DPS	Controls the number of cars to be allocated and the timing of car allocation in order to meet increased demands for downward travel during office leaving time, hotel check-out time, etc. to minimize passenger waiting time.	—	Ⓞ	Ⓞ
Dynamic Rule-set Optimizer	DRO	Traffic flows in a building are constantly predicted using neural network technology, and an optimum rule-set for group control operations is selected through real-time simulations based on prediction results.	—	—	Ⓢ
Elevator Call System with Smartphone	ELCS-SP	Users can call an elevator remotely by accessing a dedicated website with a smartphone. By eliminating the need to touch a call button in the elevator lobby or car, the system provides increased convenience and comfort to users.	Ⓞ#1	Ⓞ#1	Ⓞ#1
Energy-saving Operation — Allocation Control	ESO-W	The system selects the elevator that best balances operational efficiency and energy consumption according to each elevator's current location and passenger load as well as predicted congestion levels throughout the day.	—	—	Ⓢ
Energy-saving Operation — Power Reduction during Off-peak	ESO-A	To save energy, some elevators are automatically put into sleep mode if there are no calls for a specified period.	Ⓞ†	Ⓞ	Ⓢ
Energy-saving Operation — Speed Control	ESO-V	To save energy, the car speed is automatically reduced to some extent, but not so much that it adversely affects passenger waiting time.	—	Ⓞ	Ⓞ
Expert System and Fuzzy Logic	—	Artificial expert knowledge, which has been programmed using "expert system" and "fuzzy logic", is applied to select the ideal operational rule which maximizes the efficiency of group control operations.	—	Ⓢ	Ⓢ
Forced Floor Stop	FFS	All cars in a bank automatically make a stop at a predetermined floor on every trip without being called.	Ⓞ	Ⓞ	Ⓞ
Intense Up Peak	IUP	To maximize transport efficiency, an elevator bank is divided into two groups of cars to serve upper and lower floors separately during up peak. In addition, the number of cars to be allocated, the timing of car allocation to the lobby floor, the timing of door closing, etc. are controlled based on predicted traffic data.	—	—	Ⓞ
Light-load Car Priority Service	UCPS	When traffic is light, empty or lightly-loaded cars are given higher priority to respond to hall calls in order to minimize passenger travel time. (Cannot be combined with hall position indicators.)	—	Ⓞ#1	Ⓞ
Lunchtime Service	LTS	During the first half of lunchtime, calls for a restaurant floor are served with higher priority, and during the latter half, the number of cars allocated to the restaurant floor, the allocation timing for each car and the door opening and closing timing are all controlled based on predicted data.	—	Ⓞ	Ⓞ
Main Floor Changeover Operation	TFS	This feature is effective for buildings with two main (lobby) floors. The floor designated as the "main floor" in a group control operation can be changed as necessary using a manual switch.	Ⓞ	Ⓞ	Ⓞ
Main Floor Parking	MFP	An available car always parks on the main (lobby) floor with the doors open. (In China, the car parks with the doors closed.)	Ⓞ	Ⓞ	Ⓞ
Peak Traffic Control	PTC	A floor which temporarily has the heaviest traffic is served with higher priority over other floors, but not to the extent that it interferes with the service to other floors.	—	Ⓢ	Ⓢ
Psychological Waiting Time Evaluation	—	Cars are allocated according to the predicted psychological waiting time for each hall call. The rules evaluating psychological waiting time are automatically changed in a timely manner in response to actual service conditions.	—	Ⓢ	Ⓢ
Special Car Priority Service	SCPS	Special cars, such as observation elevators and elevators with basement service, are given higher priority to respond to hall calls. (Cannot be combined with hall position indicators.)	—	Ⓞ#1	Ⓞ
Special Floor Priority Service	SFPS	Special floors, such as floors with VIP rooms or executive rooms, are given higher priority for car allocation when a call is made on those floors. (Cannot be combined with hall position indicators.)	—	Ⓞ#1	Ⓞ
Strategic Overall Spotting	SOHS	To reduce passenger waiting time, cars which have finished service are automatically directed to positions where they can respond to predicted hall calls as quickly as possible.	Ⓢ†	Ⓢ	Ⓢ
Up Peak Service	UPS	Controls the number of cars to be allocated to the lobby floor, as well as the car allocation timing, in order to meet increased demands for upward travel from the lobby floor during office starting time, hotel check-in time, etc. and minimize passenger waiting time.	—	Ⓞ	Ⓞ
VIP Operation	VIP-S	A specified car is withdrawn from group control operation for VIP service operation. When activated, the car responds only to existing car calls, moves to a specified floor and parks there with the doors open. The car then responds only to car calls.	Ⓞ†#1	Ⓞ	Ⓞ

Feature	Abbreviation	Description	1C to 2C 2BC	3C to 4C ΣAI-22	3C to 8C ΣAI-2200C
<b>SIGNAL AND DISPLAY FEATURES</b>					
Auxiliary Car Operating Panel	ACS	An additional car control panel which can be installed for large-capacity elevators, heavy-traffic elevators, etc.	Ⓞ	Ⓞ	Ⓞ
Basic Announcement	AAN-B	A synthetic voice (and/or buzzer) alerts passengers inside a car that elevator operation has been temporarily interrupted by overloading or a similar cause. (Available in limited languages.)	Ⓢ	Ⓢ	Ⓢ
Car Arrival Chime	AECC (car)	Electronic chimes sound to indicate that a car will soon arrive. (The chimes are mounted either on the top and bottom of the car, or in each hall.)	Ⓞ	Ⓞ	—
	AECH (hall)		Ⓞ	Ⓞ	Ⓢ
Car Information Display	CID	This 10.4- or 15-inch LCD for car front return panels shows the date and time, car position, travel direction and elevator status messages. * Please consult our local agents if you would like to display a video or a slideshow of still images on the screen.	Ⓞ#1	Ⓞ#1	Ⓞ#1
Car LCD Position Indicator	CID-S	This 5.7-inch LCD for car operating panels shows the date and time, car position, travel direction and elevator status messages.	Ⓞ	Ⓞ	Ⓞ
Flashing Hall Lantern	FHL	A hall lantern, which corresponds to a car's service direction, flashes to indicate that the car will soon arrive.	Ⓞ	Ⓞ	Ⓢ
Hall Information Display	HID	This 10.4- or 15-inch LCD for elevator halls shows the date and time, car position, travel direction and elevator status messages. * Please consult our local agents if you would like to display a video or a slideshow of still images on the screen.	Ⓞ#1	Ⓞ#1	—
Hall LCD Position Indicator	HID-S	This 5.7-inch LCD for elevator halls shows the date and time, car position, travel direction and elevator status messages.	Ⓞ	Ⓞ	—
Immediate Prediction Indication	AIL	When a passenger has registered a hall call, the best car to respond to that call is immediately selected, the corresponding hall lantern lights up and a chime sounds once to indicate which doors will open.	—	—	Ⓞ
Intercommunication System	ITP	A system which allows communication between passengers inside a car and the building personnel.	Ⓞ	Ⓞ	Ⓞ
Second Car Prediction	TCP	When a hall is crowded to the extent that one car cannot accommodate all waiting passengers, the hall lantern of the next car to serve the hall will light up.	—	—	Ⓞ
Sonic Car Button — Click Type	ACB	A click-type car button which emits electronic beep sounds when pressed to indicate that the call has been registered.	Ⓞ	Ⓞ	Ⓞ
Voice Guidance System	AAN-G	Information on elevator service such as the current floor or service direction is given to the passengers inside a car.	Ⓞ	Ⓞ	Ⓞ

Notes: 1C-2BC (1-car selective collective) - Standard, 2C-2BC (2-car group control system) - Optional  
 ΣAI-22 (3- to 4-car group control system) - Optional, ΣAI-2200C (3- to 8-car group control system) - Optional  
 Ⓢ=Standard Ⓞ=Optional †= Not applicable to 1C-2BC —= Not applicable  
 #1: Please consult our local agents for the production terms, etc.

# Specifications

## Capacity and Speed\*1

Rated capacity (kg)	Number of persons	Rated speed (m/sec)											Mitsubishi Electric Standard	EN81-1
		2.0	2.5	3.0	3.5	4.0	5.0	6.0	7.0	8.0	9.0	10.0		
750	10	○	○	○	○	○	○	○	○	○	○	○		☆
	11												☆	
900	12	○	○	○	○	○	○	○	○	○	○	○		☆
	13												☆	
1000	15	●	●	●	●	●	○	○	○	○	○	○	☆	
1050	14													☆
1150	17	○	○	○	○	○	○	○	○	○	○	○	☆	
1200	16													☆
1350	18	●	●	●	●	●	●	●	○	○	○	○		☆
	20												☆	
1600	21	●	●	●	●	●	●	●	○	○	○	○		☆
	24												☆	
1800	24	●	●	●	●	●	●	●	○	○	○	○		☆
	27												☆	
2000	26	●	●	●	●	●	●	●	○	○	○	○		☆
	30												☆	
2250	30	○	○	○	○	○	○	○	○	○	○	○		☆
	34												☆	
2500	33	○	○	○	○	○								☆
	38												☆	
3000	40	○	○	○	○	○								☆
	46												☆	

Note:  
 \*1: The symbol ○ shown in the table indicates that a technical inquiry is required.  
 The symbol ● shown in the table indicates that a technical inquiry is required depending on conditions.

## Specifications\*2

Rated speed (m/sec)	2.0	2.5	3.0	3.5	4.0	5.0	6.0	7.0	8.0	9.0	10.0	
Maximum number of stops	64							Please consult our local agents.				
Maximum travel (m)	250 *3							Please consult our local agents.				
Minimum floor to floor height (mm)	2500 *4											

Notes:  
 \*2: Please consult our local agents if the maximum travel exceeds the values specified in the above table.  
 \*3: Excluding the rated capacity 2250kg to 3000kg. Please consult our local agents for maximum travel.  
 \*4: For some elevator specifications, the floor height (distance between floors) must be a minimum of 2500mm.  
 Please consult our local agents if the floor height is less than "Entrance height HH + 700mm".

## Door System

Standard	2-panel center opening (CO)
Optional	2-panel side sliding opening (2S) or 4-panel center opening (2CO)

## Operation System

Standard	1-car selective collective (1C-2BC)
Optional	2-car group control system (2C-2BC), 3- or 4-car group control ΣAI-22 system, or 3- to 8-car group control ΣAI-2200C system

# Important Information on Elevator Planning

## Work Not Included in Elevator Contract

- The following items are excluded from our elevator installation work. Their conditions and other details are to be conformed to the statement of local laws or our requirements on the responsibility of the building owner or general contractor.
- Construction of the elevator machine room with proper beams and slabs, equipped with a lock, complete with illumination, ventilation and waterproofing.
  - Access to the elevator machine room sufficient to allow passage of the control panel and traction machine.
  - Architectural finishing of the machine room floor, and the walls and floors in the vicinity of the entrance hall after installation has been completed.
  - Construction of an illuminated, ventilated and waterproofed hoistway.
  - The provision of a ladder to the elevator pit.
  - The provision of openings and supporting members as required for equipment installation.
  - The provision of separate beams when the hoistway dimensions markedly exceed the specifications, and intermediate beams and separator partitions when two or more elevators are installed.
  - The provision of an emergency exit door, inspection door and pit access door, when required, and access to the doors.
  - All other work related to building construction.
  - The provision of the main power and power for illumination, and their electrical switch boxes in the machine room, and laying of the wiring from the electrical room.
  - The provision of outlets and laying of the wiring in the machine room and the hoistway, plus the power from the electrical switch box.
  - The laying of conduits and wiring between the elevator pit and the terminating point for the devices installed outside the hoistway, such as the emergency bell, intercom, monitoring and security devices.
  - The power consumed in installation work and test operations.
  - All the necessary building materials for grouting in of brackets, bolts, etc.
  - The test provision and subsequent alteration as required, and eventual removal of the scaffolding as required by the elevator contractor, and any other protection of the work as may be required during the process.
  - The provision of a suitable, locked space for the storage of elevator equipment and tools during elevator installation.
  - The security system, such as a card reader, connected to our elevator controller, when supplied by the building owner or general contractor.

Note: Work responsibilities in installation and construction shall be determined according to local laws.

## Elevator Site Requirements

- The temperature of the machine room and elevator hoistway shall be below 40°C.
- The following conditions are required for maintaining elevator performance.
  - a. The relative humidity shall be below 90% on a monthly average and below 95% on a daily average.
  - b. Prevention shall be provided against icing and condensation occurring due to a rapid drop in the temperature in the machine room and elevator hoistway.
  - c. The machine room and the elevator hoistway shall be finished with mortar or other materials so as to prevent concrete dust.
- Voltage fluctuation shall be within a range of +5% to -10%.

## Ordering Information

Please include the following information when ordering or requesting estimates:

- The desired number of units, speed and loading capacity.
- The number of stops or number of floors to be served.
- The total elevator travel and each floor-to-floor height.
- Operation system.
- Selected design and size of car.
- Entrance design.
- Signal equipment.
- A sketch of the part of the building where the elevators are to be installed.
- The voltage, number of phases, and frequency of the power source for the motor and lighting.





## State-of-the-Art Factories... For the Environment. For Product Quality.

Our elevators and escalators are currently operating in approximately 90 countries around the globe. Built placing priority on safety, our elevators, escalators and building system products are renowned for their excellent efficiency, energy savings and comfort. The technologies and skills cultivated at the Inazawa Building Systems Works in Japan and 12 global manufacturing factories are utilized in a worldwide network that provides sales, installation and maintenance in support of maintaining and improving product quality. As a means of contributing to the realization of a sustainable society, we consciously consider the environment in business operations, proactively work to realize a low-carbon, recycling-based society, and promote the preservation of biodiversity.

### ISO9001/14001 certification

Mitsubishi Electric Building Solutions Corporation Inazawa Building Systems Works has acquired ISO 9001 certification from the International Organization for Standardization based on a review of quality management. The plant has also acquired environmental management system standard ISO 14001 certification.



## MITSUBISHI ELECTRIC BUILDING SOLUTIONS CORPORATION

HEAD OFFICE : TOKYO BLDG., 2-7-3, MARUNOUCHI, CHIYODA-KU, TOKYO 100-8310, JAPAN

[www.MitsubishiElectric.com/elevator](http://www.MitsubishiElectric.com/elevator)

**⚠ Safety Tips:** Be sure to read the instruction manual fully before using this product.